



swiss bed concept



BOX Spring *Massiva*



5 Schritte zum Boxspring-*Comfort* Bett

5 étapes vers votre lit Boxspring-*Comfort* | 5 steps to your bed Boxspring-*Comfort*

1. Untergestell | sommier | mattress base

Massiva-Box 26



Massiva-Box 26 in 4 Wildeiche-Ausführungen, sowie in 41 verschiedenen Stofffarben erhältlich. Holzrahmen aus Tanne oder Fichte massiv und Taschenfederkern mit 7 Zonen, 324 Federn pro Liegefläche (100/200).

Massiva-Box 26 en 4 exécutions de chêne sauvage et en 41 couleurs de tissu différentes. Cadre en bois de sapin ou d'épicéa massif et noyau de ressorts ensachés avec 7 zones, 324 ressorts par surface de couchage (100/200).

Massiva-Box 26 in 4 wild oak executions and in 41 different fabric colours available. Solid fir or spruce wooden frame and pocket spring core with 7 zones, 324 springs per lying surface (100/200).

2. Füße | pieds | feet

Ivio



Zu Massiva-Box 26 sind nur Füße oder Sockel in 10 cm Höhe möglich.

Avec Massiva-Box 26 seuls les pieds ou socle en hauteur 10 cm sont possibles.

For Massiva-Box 26 only feet or socket in height 10 cm are possible.

3. Kopfteil | tête de lit | headboard

Merano



Grosse Auswahl an Kopfteilen und Wandpaneelen, siehe Seiten 2.7–2.10, in verschiedenen Stoffen, siehe Seite 1.15.

Grand choix de têtes de lit et panneaux muraux, voir pages 2.7–2.10, dans différents tissus, voir page 1.15.

Large selection of headboards and wallpanels, see pages 2.7–2.10, in different fabrics, see page 1.15.

4. Ihre Wunschmatratze | votre matelas préféré | your preferred mattress



Wählen Sie Ihre Matratze aus verschiedenen Varianten und Härtegraden, siehe Register 10 (Matratzen).

Choisissez votre matelas dans différentes variantes et différents degrés de fermeté, voir registre 10 (matelas).

Choose your mattress in different variations and degrees of hardness, see index 10 (mattresses).

5. Ihr Wunschtopper | votre surmatelas préféré | your preferred mattress topper



Wählen Sie zwischen 6 Möglichkeiten für Ihren persönlichen Komfort, siehe Register 11 (Topper).

Choisissez entre 6 possibilités pour votre confort personnel, voir registre 11 (surmatelas).

Choose between 6 possibilities for your personal comfort, see index 11 (topper).

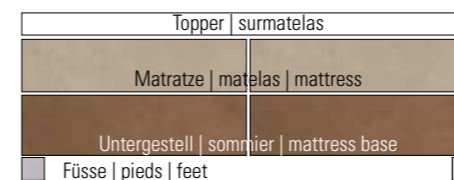

Wir bieten das Untergestell in allen Breiten 2-sektorig an. Sie entscheiden je nach Schlafgewohnheiten, ob 1 oder 2 Matratzen und 1 oder 2 Topper für Sie ideal sind.

Nous proposons le sommier dans toutes les largeurs en 2 pièces. Vous décidez en fonction de vos habitudes de sommeil si 1 ou 2 matelas et si 1 ou 2 surmatelas vous convient le mieux.

We offer the mattress base in all widths in 2 pieces. You decide, depending on your sleeping habits whether 1 or 2 mattresses and whether 1 or 2 toppers are ideal for you.

Massiva-Box 26

Breiten | largeurs | widths
160, 180, 200 cm

Längen | longueurs | lengths
200, 210, 220 cm

Höhe | hauteur | height
26 cm

Massiva-Move 26

Breiten | largeurs | widths
160, 180, 200 cm

Längen | longueurs | lengths
200, 210, 220 cm

Höhe | hauteur | height
26 cm

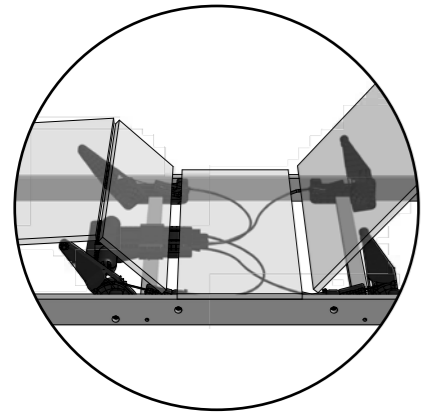

Bei den Boxspring-Motorbetten «Move 26» wird die Technik OCTObox eingebaut. Dieses weltweit einzigartige und patentierte Antriebskonzept reduziert das Gewicht und überzeugt durch seine enorme Systemkraft, angetrieben durch 2 flüsterleise Motoren. Zudem bietet das Konzept eine stufenlose Verstellung der Liegefläche in fast jede gewünschte Position. Es werden modernste Werkstoffe verwendet, um ein Höchstmass an Stabilität und Funktionalität zu gewährleisten.

Motor | moteur | motor

- Spannung nur 24 V
- gefertigt nach VDE, Schutzart IP20
- sehr geringer Standby-Verbrauch nach EU Ökodesign-Richtlinie
- Notabsenkung mechanisch

- Funkfernbedienung mit Soft-touch, inkl. LED-Hintergrundbeleuchtung
- mit Haltetasche für Fernbedienung in passender Farbe der Box

- stoffbezogener Matratzenbügel, verhindert das Rutschen nach vorne

Zur Befestigung aller Kopfteile an Massiva-Move 26 benötigen Sie zwingend ein Verbindungsbrett «Board-Move», siehe Seite 2.6.

Aufgrund der elastischen, flexiblen Struktur und dadurch hohen Anpassungsfähigkeit eines Kaltschaumkerns, empfehlen wir für Boxspring-Motorbetten «Move 26» unsere Matratze VICTORIA (Register 10, Seiten 10.10–10.11.).

Stoffauswahl siehe Seite 1.15 | choix de tissus voir page 1.15 | choice of fabrics see page 1.15



Syncro

Option: Synchronkabel siehe Seite 2.6 | câble de synchronisation voir page 2.6 | synchronization cable see page 2.6

La technique OCTObox est désormais intégrée aux lits à moteur Boxspring « Move 26 ». Ce concept d'entraînement breveté et unique au monde, réduit le poids et convainc par l'énorme puissance de son système, entraîné par 2 moteurs silencieux. Le concept offre en outre un réglage en continu de la surface de couchage dans presque chaque position souhaitée. Des matériaux ultramodernes sont utilisés pour garantir un maximum de stabilité et de fonctionnalité.

- voltage seulement 24 V
- fabriqué selon VDE, type de protection IP20
- consommation très faible en mode standby selon directive sur l'écoconception EU
- abaissement de secours mécanique

- télécommande sans fil avec Soft-touch, rétro-éclairage LED inclus
- avec pochette pour télécommande assortie au coloris de la box

- support de matelas recouvert de tissu empêche le glissement vers l'avant

Pour la fixation de toutes les têtes de lit à Massiva-Move 26 une planche de raccordement « Board-Move » est indispensable, voir page 2.6.

Du fait de sa structure élastique et flexible, et par conséquent grande faculté d'adaptation du noyau en mousse froide, nous conseillons notre matelas VICTORIA pour les lits à moteur Boxspring « Move 26 » (registre 10, pages 10.10–10.11.).

The Boxspring motor beds «Move 26» are fitted with OCTObox technology. This patented drive concept, which is unique in the world, reduces the weight and appeals for its tremendous system strength that is powered by 2 whisper-quiet motors. The concept also offers continuous adjustment of the lying surface into almost any desired position. Uses the latest materials in order to guarantee maximum stability and functionality.

- voltage 24 V only
- manufactured VDE, protection category IP20
- very low standby-consumption according to the EU Ecodesign Directive
- emergency-lowering mechanically

- radio remote control with soft-touch, LED background lighting inclusive
- with pocket for remote-control in matching colour of the box

- fabric-covered mattress holder, prevents sliding to the front

For fixation of all headboards to Massiva-Move 26 a connection board «Board-Move» is absolutely necessary, see page 2.6.

Because of the elastic, flexible structure and thereby high adaptability of a cold foam core, we recommend our mattress VICTORIA for Boxspring motor beds «Move 26» (index 10, pages 10.10–10.11.).

Füsse | pieds | feet

Holz | bois | wood

Ivio



Otino



Rocc



Metall | métal | metal

Caro



Jeno



Mico



Reca



Stomp



	Masse cm dim. cm	Breiten cm largeurs cm widths cm	Höhen cm hauteurs cm heights cm	Farben couleurs colours							
Holz bois wood			10	90	93	96	98				
Ivio	10 x 10		●	●	●	●	●				
Otino	18,5 x 18,5		●		●	●	●				
Rocc		160, 180, 200	●	●	●	●	●				
Metall métal metal			10	00	04	16	42	43	45		
Caro	6 x 6		●	●		●	●	●	●		
Jeno	12 x 5		●		●	●					
Mico	8 x 8		●			●	●	●	●		
Reca	24 x 12		●				●	●			
Stomp	∅8		●	●			●				

Ausführungen | exécutions | executions

Holz | bois | wood



90 Wildeiche Vintage natur, geölt
Chêne nouveau Vintage naturel, huilé
Wildoak Vintage natural, oiled



93 Wildeiche natur, gebürstet, geölt
Chêne nouveau naturel, brossé, huilé
Wildoak natural, brushed, oiled



96 Wildeiche pure, gebürstet, geölt
Chêne nouveau pure, brossé, huilé
Wildoak pure, brushed, oiled



98 Wildeiche coffee, gebürstet, geölt
Chêne nouveau coffee, brossé, huilé
Wildoak coffee, brushed, oiled

LED-Light Profil



für Sockelbeleuchtung von Rocc | éclairage de socle pour Rocc | socket lighting to Rocc
siehe Register 1, Seite 1.2 | voir registre 1, page 1.2 | see index 1, page 1.2

Metall | métal | metal



00 Chrom



04 Used



16 Anthracit



42 Alu



43 Inox



45 Iron

Chrom = Metall verchromt | métal chromé | metal chrome-plated

Used = Metall galvanisiert | métal galvanisé | metal galvanised

Anthracit = Metall pulverbeschichtet | métal thermolaqué | metal powder-coated

Alu = Metall pulverbeschichtet | métal thermolaqué | metal powder-coated

Inox = Edelstahl gebürstet | acier inoxydable brossé | stainless steel brushed

Iron = Metall geflammt, pulverbeschichtet | métal flammé, thermolaqué | metal mottled, powder-coated

3 Komponenten für eine flexible Liegefläche

3 composants pour un couchage flexible | 3 components for a flexible lying surface

Massiva-Move 26

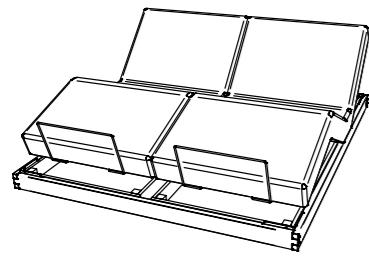

Untergestell | sommier | mattress base

Board-Move

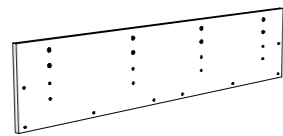

Verbindungs Brett | planche de raccordement | connection boardbase

Torino

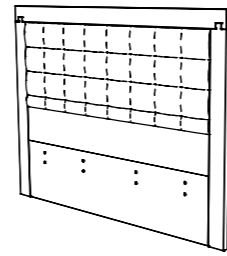

Kopfteil | tête de lit | headboard

Board-Move



Zur Befestigung aller Kopfteile an Massiva-Move 26 benötigen Sie zwingend das Verbindungs Brett «Board-Move».

Pour la fixation de toutes les têtes de lit au Massiva-Move 26 la planche de raccordement « Board-Move » est indispensable.

For fixation of all headboards to Massiva-Move 26 the connection board «Board-Move» is absolutely necessary.



Komfort durch Synchronkabel | le confort par câble de synchronisation | comfort through synchronization cable

Syncro



Das Synchronkabel «Syncro» dient zum Synchronisieren von zwei nebeneinanderliegenden Motorrahmen. Mithilfe des Synchronkabels lassen sich beide Liegeflächen über jede Fernbedienung gleichmäßig einstellen.

Vorteile des Synchronkabels:

- Verwendung beider Funkfernbedienungen
- gleichmäßiges Verfahren der Antriebssysteme trotz unterschiedlicher Belastung
- Verwendung einer durchgehenden Matratze möglich

Le câble de synchronisation « Syncro » est utilisé pour synchroniser deux châssis moteurs adjacents. A l'aide du câble de synchronisation, les deux plans de couchage peuvent être réglés uniformément par chaque télécommande.

Avantages du câble de synchronisation :

- utilisation des deux télécommandes radio
- un mouvement uniforme des systèmes d'entraînement malgré des charges différentes
- possibilité d'utiliser un matelas continu

The synchronization cable «Syncro» is used to synchronise two adjacent motorised frames. With the synchronization cable, both lying surfaces can be adjusted evenly via each remote control.

Advantages of the synchronization cable:

- use of both radio remote controls
- uniform movement of the drive systems despite different loads
- use of an one-piece double-sized mattress possible

Kopfteile | têtes de lit | headboards

Holz, gepolstert | bois, rembourrées | wood, upholstered

Torino



Merano



St. Moritz



Dolomit



Massangabe der Kopfteilhöhe ist ab Boden | la hauteur de la tête de lit est mesurée à partir du sol | dimension of the headboard is the height from the floor

Stoffauswahl siehe Seite 1.15 | choix de tissus voir page 1.15 | choice of fabrics see page 1.15

Ausführungen | exécutions | executions

Holz | bois | wood



90 Wildeiche Vintage natur, geölt
Chêne nouveau Vintage naturel, huilé
Wildoak Vintage natural, oiled



93 Wildeiche natur, gebürstet, geölt
Chêne nouveau naturel, brossé, huilé
Wildoak natural, brushed, oiled



96 Wildeiche pure, gebürstet, geölt
Chêne nouveau pure, brossé, huilé
Wildoak pure, brushed, oiled



98 Wildeiche coffee, gebürstet, geölt
Chêne nouveau coffee, brossé, huilé
Wildoak coffee, brushed, oiled

Kopfteile | têtes de lit | headboards

gepolstert | rembourrées | upholstered

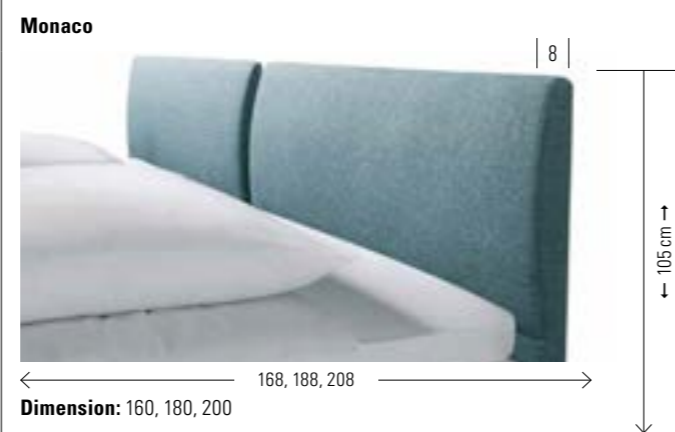
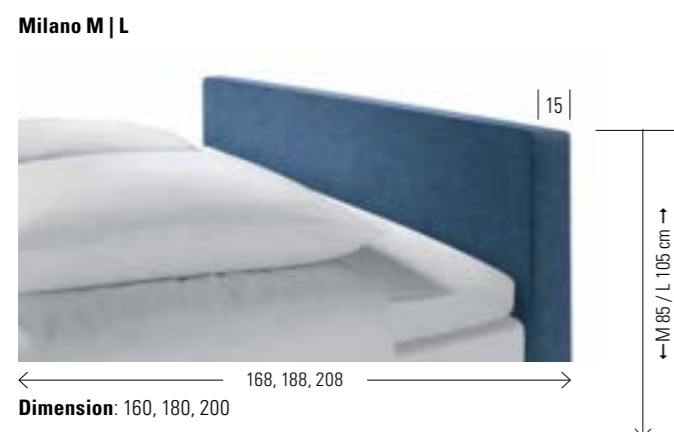
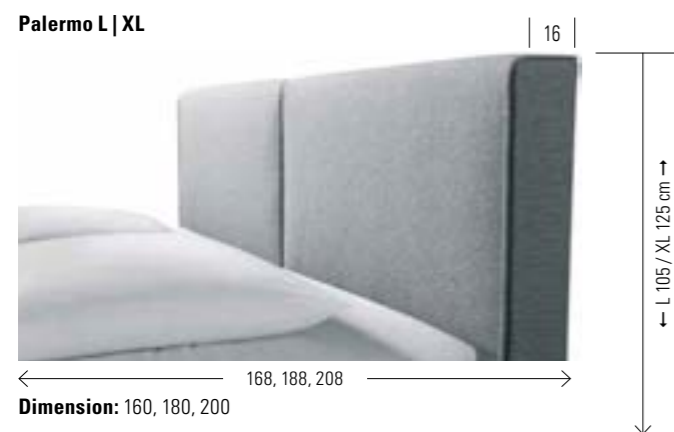
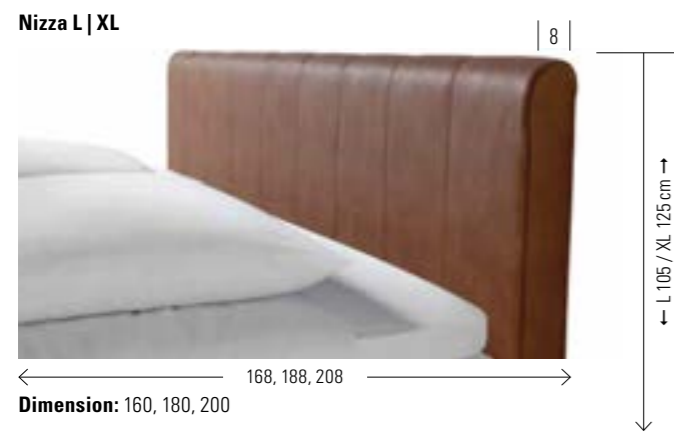
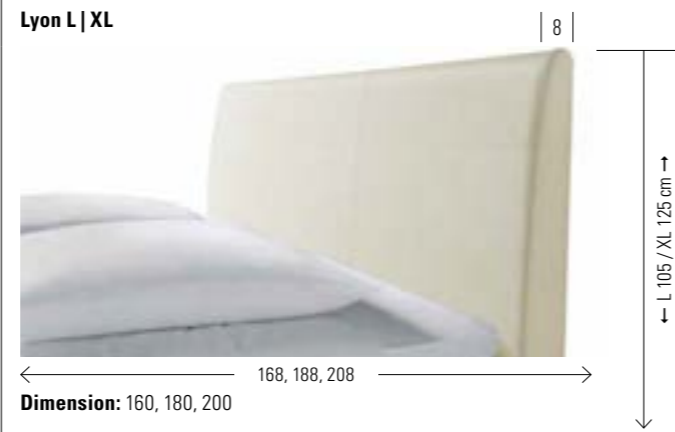

Stoffauswahl siehe Seite 1.15 | choix de tissus voir page 1.15 | choice of fabrics see page 1.15

Kopfteile | têtes de lit | headboards

gepolstert | rembourrées | upholstered

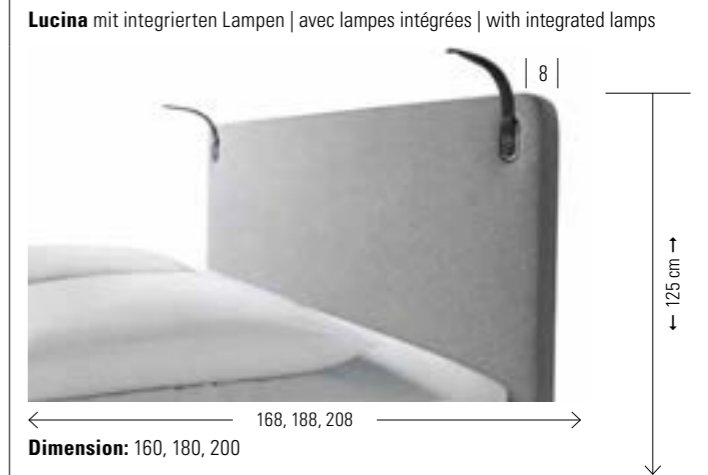
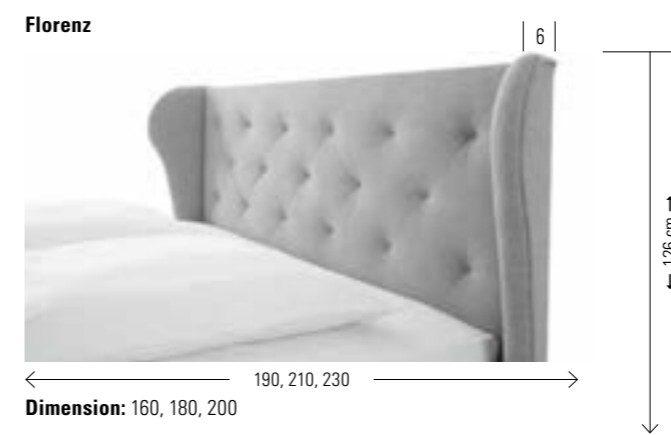
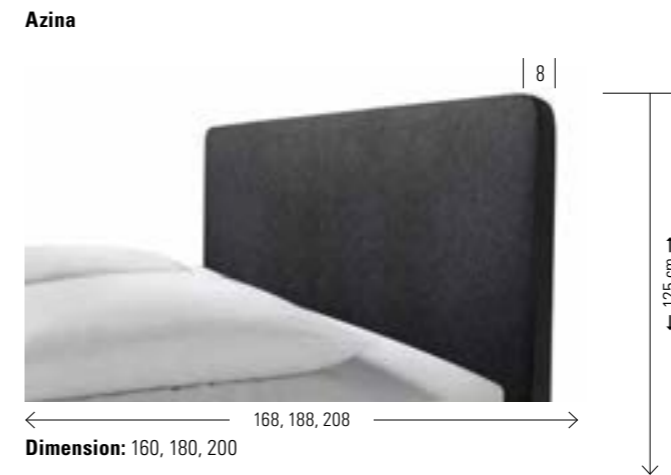

Stoffauswahl siehe Seite 1.15
Choix de tissus voir page 1.15
Choice of fabrics see page 1.15

Bei Kopfteilen Lyon und Florenz sind die Lampen nicht montierbar
Les lampes ne peuvent pas être montées sur les têtes de lit Lyon et Florence
Lamps cannot be fitted to the headboards Lyon and Florence

Lampenadapter für die Lampen | adaptateur pour les lampes | adapter for the lamps
Boa, Smart, Snake, Tina

Adapter zur Befestigung der Lampen (Register 1, Seiten 1.2–1.3) an folgenden Kopfteilen | adaptateur pour la fixation des lampes (registre 1, pages 1.2–1.3) aux têtes de lits suivantes | adapter to assemble the lamps (index 1, pages 1.2–1.3) to the following headboards

Lille, Nizza, Palermo, Milano, Azina - Seite/page 2.8–2.9

Information zu Kopfteil Lucina | informations sur la tête de lit Lucina | information about headboard Lucina

Lampe mit flexiblem Hals, USB-Anschluss und separatem Orientierungslicht für die Nacht, nur in Kombination mit Kopfteil Lucina erhältlich | lampe à cou flexible, port USB et lumière à orientation séparée pour la nuit, uniquement disponible en combinaison avec la tête de lit Lucina | lamp with flexible neck, USB connection and separate orientation light for the night, only available in combination with headboard Lucina



Lampen (2er Set) schwarz 12V DC, LED neutral, 80 lm
lampes (set de 2) noir 12V DC, LED neutre, 80 lm
lamps (set of 2) black 12V DC, LED neutral, 80 lm

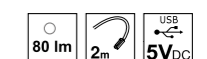

Weitere Lampen und Informationen siehe Register 1, Seiten 1.2–1.3 | davantage de lampes et informations plus détaillées voir registre 1, pages 1.2–1.3 | other lamps and detailed information see index 1, pages 1.2–1.3

Wandpaneele | panneaux muraux | wallpanels

Colina L | XL



Umbia L

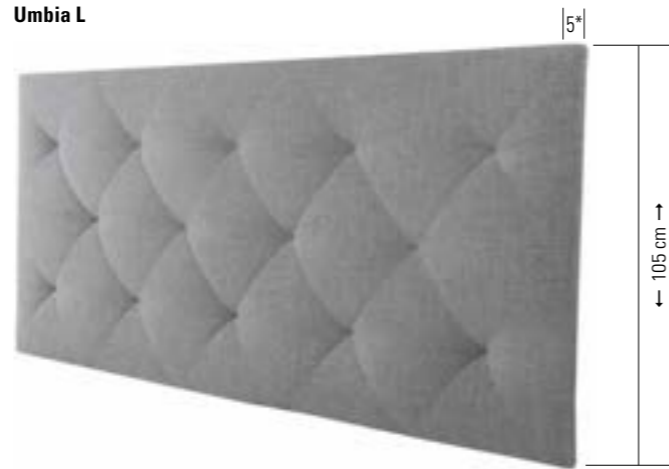

Saia M | L



Sogno L | XL



*Zusätzlich zum angegebenen Mass: Der Abstand zwischen Paneel und Wand beträgt 3 cm. | En plus de la dimension indiquée: La distance entre le panneau et le mur est de 3 cm. | Additional to the indicated dimension: The distance between panel and wall is 3 cm.

Stoffauswahl siehe Seite 1.15 | choix de tissus voir page 1.15 | choice of fabrics see page 1.15

Combino



Lampenadapter für die Lampen | adaptateur pour les lampes | adapter for the lamps

Boa, Smart, Snake, Tina

Adapter zur Befestigung der Lampen (Register 1, Seiten 1.2–1.3) an folgenden Wandpaneelen | adaptateur pour la fixation des lampes (registre 1, pages 1.2–1.3) aux panneaux muraux suivants | adapter to assemble the lamps (index 1, pages 1.2–1.3) to the following wallpanels

Colina

Lampen, 2er Set | lampes, set de 2 | lamps, set of 2

Boa chrom



12V DC, 12 LED, 60 lm

Smart black



12V DC, 30 LED, 183 lm

Smart white



12V DC, 30 LED, 183 lm

Weitere Lampen und Informationen siehe Register 1, Seiten 1.2–1.3 | davantage de lampes et informations plus détaillées voir registre 1, pages 1.2–1.3 | other lamps and detailed information see index 1, pages 1.2–1.3







Dimension cm

Cessa	Kommode	commode	chest of drawers	120/48/80
Vecio	Bank	banquette	bench	110/27/45
Cerina	Nachtisch	table de nuit	bedside table	48/43/57
Smart black	Lampen (2er Set) 12V DC, 30 LED warm weiss Dreistufenschaltung	lampes (set de 2) 12V DC, 30 LED blanc chaud interrupteur à 3 crans	lamps (set of 2) 12V DC, 30 LED warm white three-step circuit	



NEU: Matratze Majestic siehe Register 10, Seiten 10.12–10.13 |
 NOUVEAU : matelas Majestic voir registre 10, pages 10.12–10.13 |
 NEW: Mattress Majestic see index 10, pages 10.12–10.13

Dimension cm

Massiva-Box 26	Untergestell Breiten Längen	sommier largeurs longueurs	mattress base widths lengths	160, 180, 200 200, 210, 220
Jeno anthracit	Füsse Höhe	pieds hauteur	feet height	10
Dolomit	Kopfteil	tête de lit	headboard	160, 180, 200
Tex Topper	Matratze Topper Breiten Längen	matelas surmatelas largeurs longueurs	mattress mattress topper widths lengths	80, 90, 100, 160, 180, 200 200, 210, 220

Alle Polsterteile in Shine wine 680 | toutes les parties rembourrées en Shine wine 680 | all upholstery parts in Shine wine 680

Alle Holzteile in Wildeiche Vintage natur, geölt | toutes les parties en bois en chêne nouveau Vintage naturel, huilé | all wooden parts in wildoak Vintage naturel, oiled

Weitere Beimöbel siehe Register 1 | davantage d'accessoires voir registre 1 | other accessories see index 1

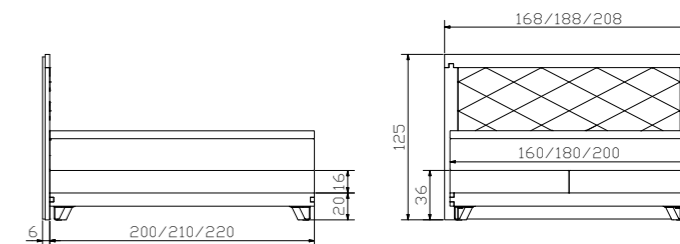



				Dimension cm
Coset	Sekretär	secrétaire	bureau	120/60/86
Ludo	Nachttisch	table de nuit	bedside table	40/40/55



Syncro
Option: Synchronkabel | câble de synchronisation | synchronization cable



Komfort durch Synchronkabel, siehe Seite 2.6 | le confort par câble de synchronisation, voir page 2.6 | comfort through synchronization cable, see page 2.6

				Dimension cm
Massiva-Move 26	Untergestell Breiten Längen	sommier largeurs longueurs	mattress base widths lengths	160, 180, 200 200, 210, 220
Rocc	Sockel Breiten Längen Höhe	socle largeurs longueurs hauteur	socket widths lengths height	160, 180, 200 200, 210, 220 10
Paris XL	Kopfteil	tête de lit	headboard	160, 180, 200
Tex Topper	Matratze Topper Breiten Längen	matelas surmatelas largeurs longueurs	mattress mattress topper widths lengths	80, 90, 100, 160, 180, 200 200, 210, 220

Alle Polsterteile in Alpina lightgrey 390 | toutes les parties rembourrées en Alpina lightgrey 390 | all upholstery parts in Alpina lightgrey 390

Alle Holzteile in Wildeiche pure, gebürstet, geölt | toutes les parties en bois en chêne nouveau pure, brossé, huilé | all wooden parts in wildoak pure, brushed, oiled

Weitere Beimöbel siehe Register 1 | davantage d'accessoires voir registre 1 | other accessories see index 1

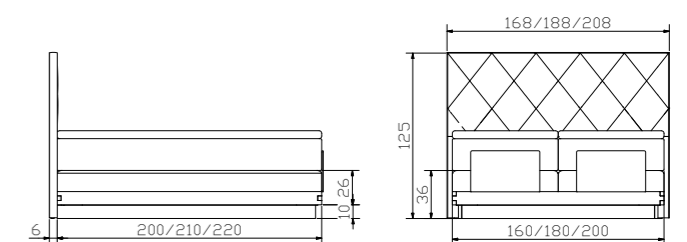



				Dimension cm
Coset	Sekretär	secrétaire	bureau	120/60/86
Tree	Nachttisch/Hocker Echtbeton grey	table de nuit/tabouret béton véritable grey	bedside table/stool real concrete grey	Ø 42/44
Pira	Nachttisch höhenverstellbar Auflageplatte Echtbeton	table de nuit réglable en hauteur plaque d'appui béton véritable	bedside table adjustable in height support plate real concrete	48/38/34–53



Lucina
Kopfteil mit integrierten Lampen | tête de lit avec lampes intégrées | headboard with integrated lamps

Lampe mit flexiblem Hals, USB-Anschluss und separatem Orientierungslicht für die Nacht, nur in Kombination mit Kopfteil Lucina erhältlich | lampe à cou flexible, port USB et lumière à orientation séparée pour la nuit, uniquement disponible en combinaison avec la tête de lit Lucina | lamp with flexible neck, USB connection and separate orientation light for the night, only available in combination with headboard Lucina

Weitere Lampen siehe Register 1 | davantage de lampes voir registre 1 | other lamps see index 1

				Dimension cm
Massiva-Box 26	Untergestell Breiten Längen	sommier largeurs longueurs	mattress base widths lengths	160, 180, 200 200, 210, 220
Jeno used	Füße Höhe	pieds hauteur	feet height	10
Lucina	Kopfteil mit integrierten Lampen Lampen (2er Set) schwarz 12V DC, LED neutral	tête de lit avec lampes intégrées lampes (set de 2) noir 12V DC, LED neutre	headboard with integrated lamps lamps (set of 2) black 12V DC, LED neutral	160, 180, 200
Tex Topper	Matratze Topper Breiten Längen	matelas surmatelas largeurs longueurs	mattress mattress topper widths lengths	80, 90, 100, 160, 180, 200 200, 210, 220

Alle Polsterteile in Alpina lightgrey 390 | toutes les parties rembourrées en Alpina lightgrey 390 | all upholstery parts in Alpina lightgrey 390

Alle Holzteile in Wildeiche natur, gebürstet, geölt | toutes les parties en bois en chêne naturel, brossé, huilé | all wooden parts in wildoak natural, brushed, oiled

Weitere Beimöbel siehe Register 1 | davantage d'accessoires voir registre 1 | other accessories see index 1

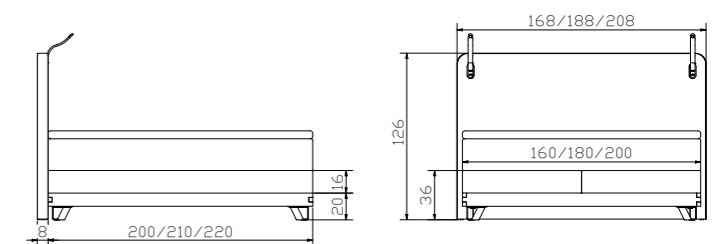



				Dimension cm
Coset	Sekretär	secrétaire	bureau	120/60/86
Vecio	Bank	banquette	bench	110/27/45
Cerina	Nachttisch	table de nuit	bedside table	48/43/57

				Dimension cm
Massiva-Box 26	Untergestell Breiten Längen	sommier largeurs longueurs	mattress base widths lengths	160, 180, 200 200, 210, 220
Rocc	Sockel Breiten Längen Höhe	socle largeurs longueurs hauteur	socket widths lengths height	160, 180, 200 200, 210, 220 10
Torino	Kopfteil	tête de lit	headboard	160, 180, 200
Tex Topper	Matratze Topper Breiten Längen	matelas surmatelas largeurs longueurs	mattress mattress topper widths lengths	80, 90, 100, 160, 180, 200 200, 210, 220

Alle Polsterteile in Campos blanc 372 | toutes les parties rembourrées en Campos blanc 372 | all upholstery parts in Campos blanc 372

Alle Holzteile in Wildeiche natur, gebürstet, geölt | toutes les parties en bois en chêne noueux naturel, brossé, huilé | all wooden parts in wildoak natural, brushed, oiled

Weitere Beimöbel siehe Register 1 | davantage d'accessoires voir registre 1 | other accessories see index 1

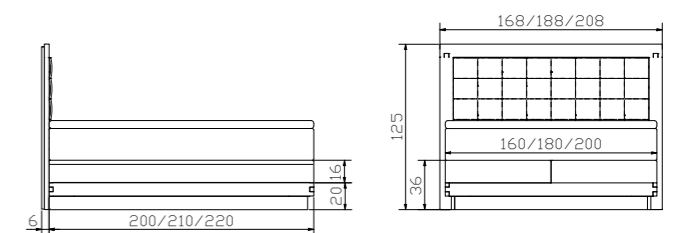



Dimension cm

Claudio inox	Herrendiener	valet	dressboy	45/28/107
Cessa	Kommode	commode	chest of drawers	120/48/80
Vecio	Bank	banquette	bench	110/27/45
Ludo	Nachttisch	table de nuit	bedside table	40/40/55

Dimension cm

Massiva-Box 26	Untergestell Breiten Längen	sommier largeurs longueurs	mattress base widths lengths	160, 180, 200 200, 210, 220
Ivio	Füsse Höhe	pieds hauteur	feet height	10
Merano	Kopfteil	tête de lit	headboard	160, 180, 200
Tex Topper	Matratze Topper Breiten Längen	matelas surmatelas largeurs longueurs	mattress mattress topper widths lengths	80, 90, 100, 160, 180, 200 200, 210, 220

Alle Polsterteile in Shine rose 681 | toutes les parties rembourrées en Shine rose 681 | all upholstery parts in Shine rose 681

Alle Holzteile in Wildeiche pure, gebürstet, geölt | toutes les parties en bois en chêne nouveau pure, brossé, huilé | all wooden parts in wildoak pure, brushed, oiled

Weitere Beimöbel siehe Register 1 | davantage d'accessoires voir registre 1 | other accessories see index 1

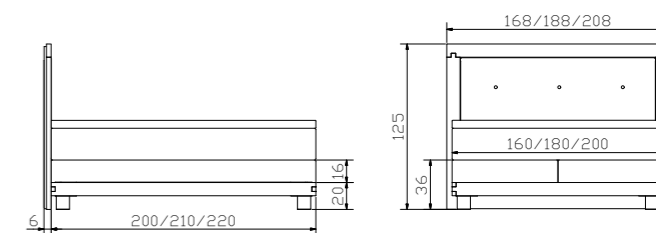



				Dimension cm
Cessa	Kommode	commode	chest of drawers	120/48/80
Cerina	Nachttisch	table de nuit	bedside table	48/43/57
LED-Light-Profil	Sockelbeleuchtung, LED Flexiband, 10 x 10 mm Profilleuchten, Funkschalter zum Ein-/Ausschalten und Dimmen 12V DC, 27,9 W, 60 LED/m warm weiss Breiten Längen	éclairage de socle, LED band flexible, 10 x 10 mm luminaires profilés, interrupteur sans fil pour allumer/éteindre ou baisser 12V DC, 27,9 W, 60 LED/m blanc chaud largeurs longueurs	socket lighting, LED flexible strip, 10 x 10 mm profile luminaires, radio switch to switch on/off and to dim 12 V DC, 27,9 W, 60 LED/m warm white widths lengths	160, 180, 200 200

				Dimension cm
Massiva-Box 26	Untergestell Breiten Längen	sommier largeurs longueurs	mattress base widths lengths	160, 180, 200 200, 210, 220
Rocc	Sockel Breiten Längen Höhe	socle largeurs longueurs hauteur	socket widths lengths height	160, 180, 200 200, 210, 220 10
Dolomit	Kopfteil	tête de lit	headboard	160, 180, 200
Drell Topper	Matratze Topper Breiten Längen	matelas surmatelas largeurs longueurs	mattress mattress topper lengths height	80, 90, 100, 160, 180, 200 200, 210, 220



Alle Polsterteile in Casual carbon 334 | toutes les parties rembourrées en Casual carbon 334 | all upholstery parts in Casual carbon 334

Alle Holzteile in Wildeiche natur, gebürstet, geölt | toutes les parties en bois en chêne naturel, brossé, huilé | all wooden parts in wildoak natural, brushed, oiled

Weitere Beilmöbel siehe Register 1 | davantage d'accessoires voir registre 1 | other accessories see index 1

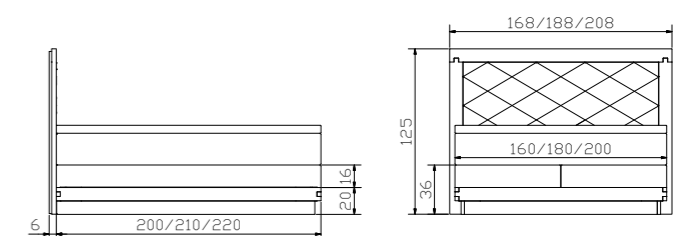



				Dimension cm
Coset	Sekretär	secrétaire	bureau	120/60/86
Vecio	Bank	banquette	bench	110/27/45
Cerina	Nachttisch	table de nuit	bedside table	48/43/57

				Dimension cm
Massiva-Box 26	Untergestell Breiten Längen	sommier largeurs longueurs	mattress base widths lengths	160, 180, 200 200, 210, 220
Rocc	Sockel Breiten Längen Höhe	socle largeurs longueurs hauteur	socket widths lengths height	160, 180, 200 200, 210, 220 10
Palermo XL	Kopfteil	tête de lit	headboard	160, 180, 200
Tex Topper	Matratze Topper Breiten Längen	matelas surmatelas largeurs longueurs	mattress mattress topper widths lengths	80, 90, 100, 160, 180, 200 200, 210, 220

Alle Polsterteile in Kitana grigio 602 | toutes les parties rembourrées en Kitana grigio 602 | all upholstery parts in Kitana grigio 602

Alle Holzteile in Wildeiche coffee, gebürstet, geölt | toutes les parties en bois en chêne nouveau coffee, brossé, huilé | all wooden parts in wildoak coffee, brushed, oiled

Weitere Beimöbel siehe Register 1 | davantage d'accessoires voir registre 1 | other accessories see index 1

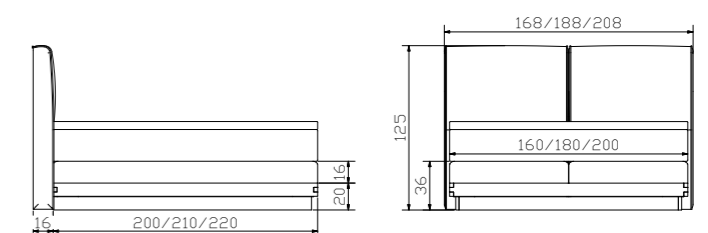



				Dimension cm
Cessa	Kommode	commode	chest of drawers	120/48/80
Seca iron	Griffe (3-er Set)	poignées (set de 3)	handles (set of 3)	
Claudio iron	Herrendiener	valet	dressboy	45/28/107
Ludo	Nachttisch	table de nuit	bedside table	40/40/55

				Dimension cm
Massiva-Box 26	Untergestell Breiten Längen	sommier largeurs longueurs	mattress base widths lengths	160, 180, 200 200, 210, 220
Otino iron	Füße Höhe	pieds hauteur	feet height	10
Lille XL	Kopfteil	tête de lit	headboard	160, 180, 200
Tex Topper	Matratze Topper Breiten Längen	matelas surmatelas largeurs longueurs	mattress mattress topper widths lengths	80, 90, 100, 160, 180, 200 200, 210, 220

Alle Polsterteile in Casual olive 333 | toutes les parties rembourrées en Casual olive 333 | all upholstery parts in Casual olive 333

Alle Holzteile in Wildeiche coffee, gebürstet, geölt | toutes les parties en bois en chêne nouveau coffee, brossé, huilé | all wooden parts in wildoak coffee, brushed, oiled

Weitere Beimöbel siehe Register 1 | davantage d'accessoires voir registre 1 | other accessories see index 1

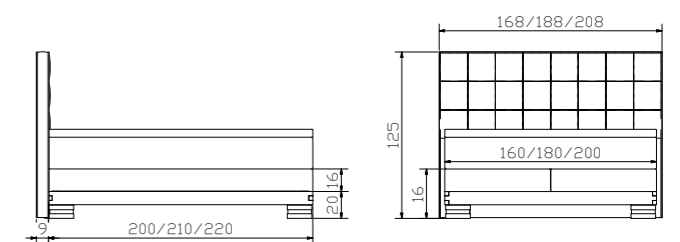



				Dimension cm
Cessa	Kommode	commode	chest of drawers	120/48/80
Seca iron	Griffe (3-er Set)	poignées (set de 3)	handles (set of 3)	
Carpi	Nachttisch	table de nuit	bedside table	52/42/34 – 53
	höhenverstellbar	réglable en hauteur	adjustable in height	

				Dimension cm
Massiva-Box 26	Untergestell	sommier	mattress base	
	Breiten	largeurs	widths	160, 180, 200
	Längen	longueurs	lengths	200, 210, 220
Rocc	Sockel	socle	socket	
	Breiten	largeurs	widths	160, 180, 200
	Längen	longueurs	lengths	200, 210, 220
	Höhe	hauteur	height	10
Sogno XL	Kopfteil	tête de lit	headboard	161, 181, 201, 221
Tex	Matratze	matelas	mattress	
Topper	Topper	surmatelas	mattress topper	80, 90, 100, 160, 180, 200
	Breiten	largeurs	widths	200, 210, 220
	Längen	longueurs	lengths	

Alle Polsterteile in Campos blanc 372 | toutes les parties rembourrées en Campos blanc 372 | all upholstery parts in Campos blanc 372
Alle Holzteile in Wildeiche Vintage natur, geölt | toutes les parties en bois en chêne nouveau Vintage naturel, huilé | all wooden parts in wildoak Vintage naturel, oiled
Weitere Beimöbel siehe Register 1 | davantage d'accessoires voir registre 1 | other accessories see index 1

