



swiss bed concept



**HASENA**  
the dream factory



# MOVIE-/SOFT-/ TOP LINE

Achten Sie auf FSC®-zertifizierte Produkte | soyez attentifs aux produits certifiés FSC® | look for FSC®-certified products



The mark of  
responsible forestry



# Bettrahmen | cadre de lit | bedframe

## Star 16 = Movie-Line



**Breiten** | largeurs | widths:  
90, 100, 120, 140, 160, 180, 200 cm

**Längen** | longueurs | lengths:  
190, 200, 210, 220 cm

**Einlegetiefe** | hauteur encastrable | insertion depth:  
16 cm

## Advance 18 = Top-Line



**Breiten** | largeurs | widths:  
90, 100, 120, 140, 160, 180, 200 cm

**Längen** | longueurs | lengths:  
190, 200, 210, 220 cm

**Einlegetiefe** | hauteur encastrable | insertion depth:  
18 cm

**Bettrahmen MDF ummantelt in unten genannten Ausführungen. Die Holzstrukturen sind Nachbildungen. Gehrungsteile in alu und chrom inklusive.**  
Cadre de lit en MDF dans les exécutions ci-dessous. Les structures en bois sont laminées. Angles décoratifs en alu et chrome inclus.  
Bedframe in MDF in bellow mentioned executions. All wooden structures are laminated. Deco corners in alu and chrome are included.

## Ausführungen | exécutions | executions

### Holz | bois | wood

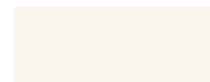

**10 Weiss**  
Blanc  
White



**16 Anthracit**



**30 Walnuss**  
Noyer  
Walnut



**35 Hochglanz weiss\***  
Blanc brillant  
White highgloss



**49 Beton Nachbildung**  
Béton laminé  
Concrete laminated

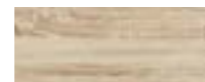

**50 Eiche sägerauh natur**  
Chêne brut de sciage naturel  
Oak rough sawn natural

\*nur | uniquement | only  
**Star 16**  
**Advance 18**

**Die Holzstrukturen sind Nachbildungen.** | Les structures bois sont en bois laminé. |  
The wood structures are laminated.



**55 Esche hell**  
Frêne clair  
Ash light



**59 Buche**  
Hêtre  
Beech

# Bettrahmen | cadre de lit | bedframe

## Noble 14 = Soft-Line



**Breiten** | largeurs | widths:  
90, 100, 120, 140, 160, 180, 200 cm

**Längen** | longueurs | lengths:  
190, 200, 210, 220 cm

**Einlegetiefe** | hauteur encastrable | insertion depth:  
14 cm

## Prestige 18 = Top-Line



**Breiten** | largeurs | widths:  
90, 100, 120, 140, 160, 180, 200 cm

**Längen** | longueurs | lengths:  
190, 200, 210, 220 cm

**Einlegetiefe** | hauteur encastrable | insertion depth:  
18 cm

**Bettrahmen MDF ummantelt in den Ausführungen auf S. 3.4. Die Holzstrukturen sind Nachbildungen. Gehrungsteile in alu und chrom inklusive.**  
Cadre de lit en MDF dans les exécutions à la page 3.4. Les structures en bois sont laminées. Angles décoratifs en alu et chrome inclus.  
Bedframe in MDF in mentioned executions on page 3.4. All wooden structures are laminated. Deco corners in alu and chrome are included.

## Traversen | traverses | bars

Wir empfehlen grundsätzlich den Einsatz von **Crosstraver** (Quertraverse) oder **Midtraver** (Längstraverse). Für Betten ab 160 cm mit 2 Lattenrosten oder für den Motorrahmeneinbau eine **Midtraver** (Längstraverse). Midtraver und Crosstraver-Twin sind mit den Füßen Evio, Lovie-Box, Practico-Box und Vilo nicht einsetzbar.

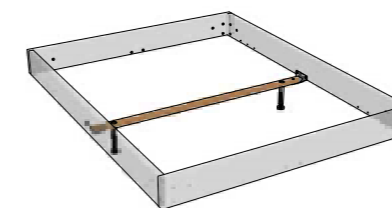

**Crosstraver**  
Quertraverse  
Traverse transversale  
Central cross bar

Nous recommandons en général l'utilisation de **Crosstraver** (traverse transversale) ou **Midtraver** (traverse centrale). Pour un cadre de lit à partir de 160 cm avec 2 sommiers ou pour l'encastrement d'un sommier à moteur une **Midtraver** (traverse centrale). Midtraver et Crosstraver-Twin non compatibles avec les pieds Evio, Lovie-Box, Practico-Box et Vilo.

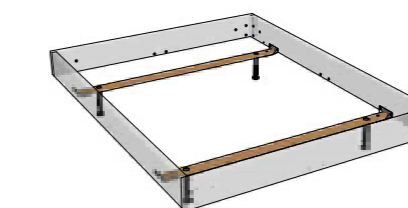

**Crosstraver-Twin**  
Quertraversen  
Traverses transversales  
Cross bars

We recommend basically the insertion of **Crosstraver** (central cross bar) or **Midtraver** (central bar). For beds wider than 160 cm with 2 slats or motorframes a **Midtraver** (central bar). Midtraver and Crosstraver-Twin are not suitable with feet Evio, Lovie-Box, Practico-Box and Vilo.

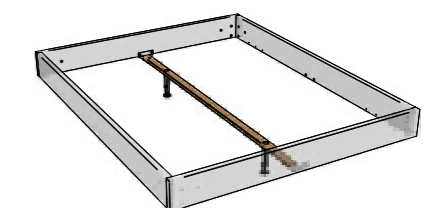

**Midtraver**  
Längstraverse  
Traverse centrale  
Central bar

# Füsse | pieds | feet

## Holz | bois | wood



	Masse cm dim. cm	Breiten cm largeurs cm widths cm	Höhen cm hauteurs cm heights cm	Holzfarben couleurs bois colours wood	Hochglanz Brillant Highgloss
<b>Holz   bois   wood</b>			10 20 25 30	06 10 16 30 49 50 55	35
Cantu	8x8				
Evio		90-200			
Ivio	10x10				
Juve	6-8x6-8				
Lovi-Box (1 Schublade/tiroir/drawer)		90-140			
Lovi-Box (2 Schublade/tiroirs/drawers)		140-200			
Masi	6x4				
Practico-Box (inkl. Boden fond inclus   bottom included)		90-200			
Vegas*	20x20		16 cm		
Vilo		90-200			

\* nur mit Star 16-Rahmen möglich (Vegas + Practico-Box aus MDF ummantelt). Holzfüsse sind aus Massivholz | uniquement possible avec cadre Star 16 (Vegas + Practico-Box en mdf laminé). Pieds en bois massif | only possible with frame Star 16 (Vegas + Practico-Box in mdf coated). Wooden feet are of solid wood.

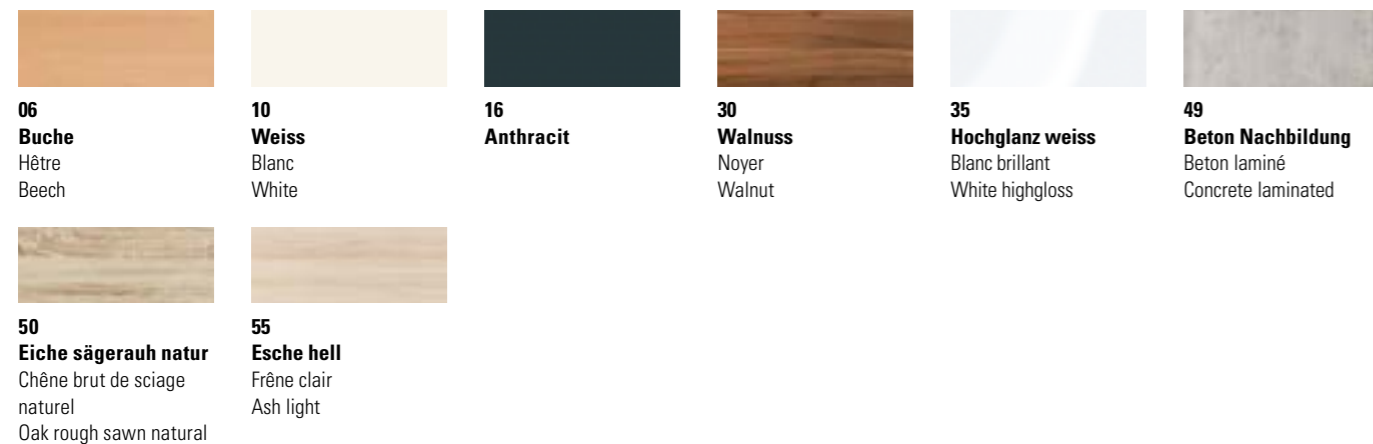

# Füsse | pieds | feet

## Metall | métal | metal



	Masse cm dim. cm	Breiten cm largeurs cm widths cm	Höhen cm hauteurs cm heights cm	Metallfarben couleurs métal colours metal	Hochglanz Brillant Highgloss
<b>Metall   métal   metal</b>			10 20 25 30	00 04 10 16 40 41 42 43 45	35
Caro	6x6				
Cielo <sup>▲</sup>		120-200			
Fasio	∅ 5/9				
Gina*	3,5x3,5				
Grado	∅ 6/10				
Indus	6x2	140-200			
Jeno	12x5				
Jump	∅ 10/12			chromfarbig   teinté chrome   chrome coloured	
Mico	8x8				
Quada	20x6,5				
Rally	∅ 10				
Reca	24x12				
Road**	∅ 13				
Slid	8/1	140-200			
Soko	∅ 6				
Stomp	∅ 8				
Tondo	∅ 3,5				

\* nur mit Star 16 / Advance 18 Bettrahmen möglich | uniquement possible avec cadre de lit Star 16 / Advance 18

\*\* Füsse fixiert, Rollen nur optisch | pieds fixes, roulettes uniquement décoration | feet fixed, castors only visual

<sup>▲</sup> Curty Vorhang und Vela Baldachin-Tuch siehe Register 2, Seite 12 | Curty rideau et Vela tissu de baldaquin voir registre 2, page 12 | Curty curtain and Vela canopy cloth see index 2, page 12

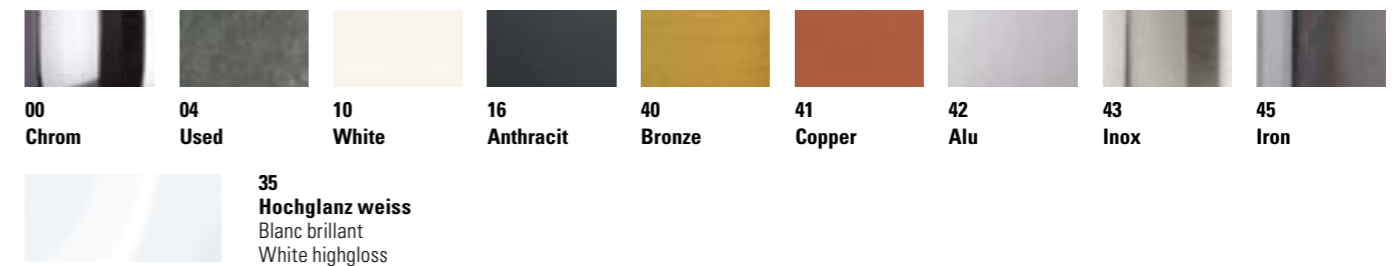

# Bettkasten mit Holzkufe | tiroir de lit avec patins en bois | bed drawer with wooden vat

## Lovie-Box + Covero - 1 FSC 90-140 cm 1 Schublade | 1 tiroir | 1 drawer

**Stauraum** | compartiment de rangement | storage space:  
134×61×16 cm

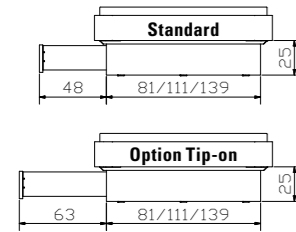

**Standard:** gedämpfter Selbststeinzug Blumotion von BLUM  
**Option:** Tip-on-Öffnung mit Vollauszug von BLUM

## Lovie-Box + Saceto - 1 FSC 140-200 cm 2 Schubladen | 2 tiroirs | 2 drawers

**Stauraum** | compartiment de rangement | storage space:  
2×134×61×16 cm

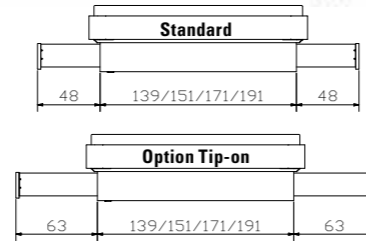

**standard:** système d'amortissement Blumotion de BLUM  
**option:** ouverture Tip-on avec sortie totale de BLUM  
**standard:** soft closing runner Blumotion of BLUM  
**option:** opening Tip-on with full extension of BLUM

## Roll-Box 20/25 FSC



### Voraussetzungen für Einsatz Bettkasten

**Generell**  
Bettfußhöhe von mindestens 20 oder 25 cm erforderlich.

**Seitlich**  
mit Midtraver möglich.

**Optionen**  
Deckel Covero in weiss, Stoffabdeckung Saceto in Polyester grau.

## Roll-Box 20/25 + Covero FSC



### Conditions d'utilisation d'un tiroir de lit

**En général**  
Une hauteur de pieds de lit d'au moins 20 cm ou 25 cm est nécessaire.

**Insertion latérale**  
avec Midtraver possible.

**Options**  
Couvercle Covero en blanc, tissu de protection Saceto en polyester gris.

## Roll-Box 20/25 + Saceto FSC



### Requirements for using bed drawer

**General**  
Feet of bed need a minimum height of 20 cm or 25 cm.

**Laterally**  
with Midtraver possible.

**Options**  
Covero in white, tissue of protection Saceto in polyester grey.



### Roll-Box 20

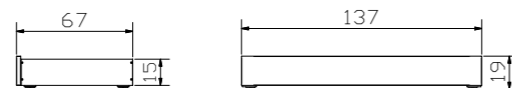

### Roll-Box 25

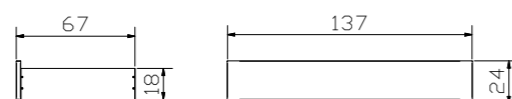

**Stauraum** | compartiment de rangement | storage space

Roll-Box 20	=	134×61×13 cm
Roll-Box 25	=	134×61×16 cm

# Bettkasten | coffre à literie | bedding box

## Practico-Box + Noble 14 + Ultrafree-Lift KF



### Ultrafree-Lift KF

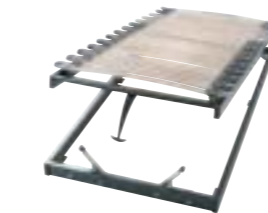

Box = inkl. Boden, Anwendung siehe Seiten 3.52/53 + 3.64/65  
**zu Practico-Box:**  
Lattenrost **Ultrafree-Lift KF**  
Kopf-/Fussverstellung  
Rahmenholme Höhe 7 cm und 28 Federleisten aus Buchenschichtholz  
Gesamthöhe 11 cm

Lattenrost **Econom-move**  
Unverstellbar  
Rahmenholme Höhe 6 cm und 28 Federleisten aus Buchenschichtholz  
Gesamthöhe 9 cm

inkl. Gasdruckfedern und allen Beschlägen

**Details zu Ultrafree-Lift KF und Econom-move**  
siehe Register 13, Seite 6

## Practico-Box + Advance 18 + Econom-move



### Econom-move

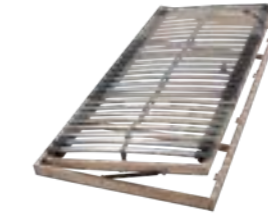

box = fond inclus, utilisation voir pages 3.52/53 + 3.64/65  
**pour box Practico-Box:**  
Sommier **Ultrafree-Lift KF**  
Tête et pied réglables  
Cadre, hauteur 7 cm et 28 lattes en hêtre multiplis  
Hauteur totale 11 cm

Sommier **Econom-move**  
Non réglable  
Cadre, hauteur 6 cm et 28 lattes en hêtre multiplis  
Hauteur totale 9 cm

Pistons à gaz et toute la quincaillerie inclus

**Détails pour Ultrafree-Lift KF et Econom-move**  
voir registre 13, page 6

**Stauraum** | compartiment de rangement | storage space

90 × 200/210/220	=	81 × 190/200/210 × 24 cm
100 × 200/210/220	=	91 × 190/200/210 × 24 cm
120 × 200/210/220	=	111 × 190/200/210 × 24 cm
140 × 200/210/220	=	131 × 190/200/210 × 24 cm
160 × 200/210/220	=	74 × 190/200/210 × 24 (2 x) cm
180 × 200/210/220	=	84 × 190/200/210 × 24 (2 x) cm
200 × 200/210/220	=	94 × 190/200/210 × 24 (2 x) cm

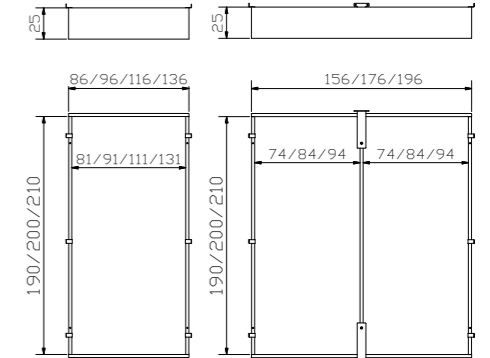

box = bottom incl., handling see pages 3.52/53 + 3.64/65  
**for Practico-Box:**  
Slats **Ultrafree-Lift KF**  
Head/footpiece adjustable  
Frame, height 7 cm and 28 slats are of beech veneer board  
Total height 11 cm

Slats **Econom-move**  
Not adjustable  
Frame, height 6 cm and 28 slats are of beech veneer board  
Total height 9 cm

Pneumatic compression spring and all fittings included

**Details for Ultrafree-Lift KF and Econom-move**  
see index 13, pages 6

# Himmelbett ohne Grenzen lit à baldaquin sans frontières | canopy bed without borders

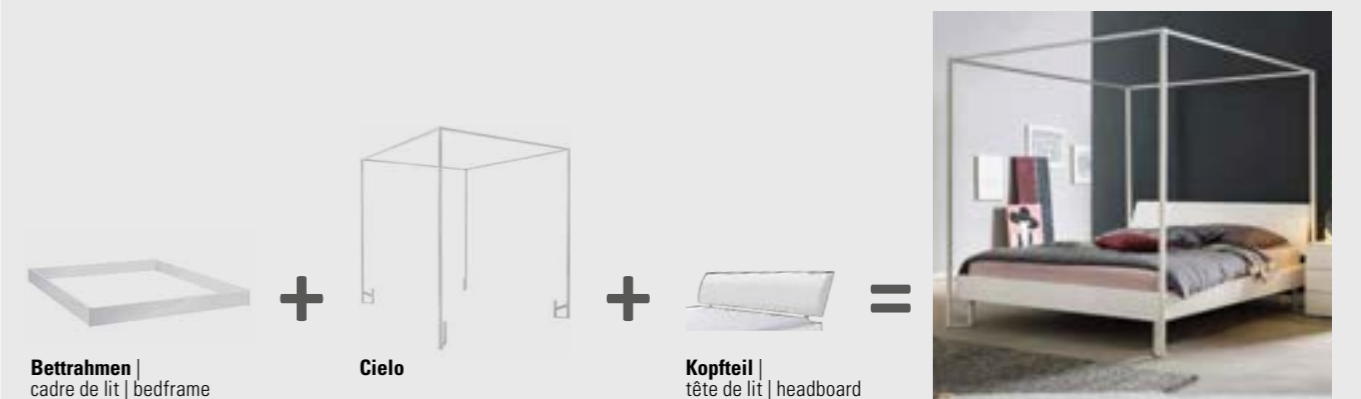

**Bettrahmen** | cadre de lit | bedframe

**Cielo**

**Kopfteil** | tête de lit | headboard

# Kopfteile | têtes de lit | headboards

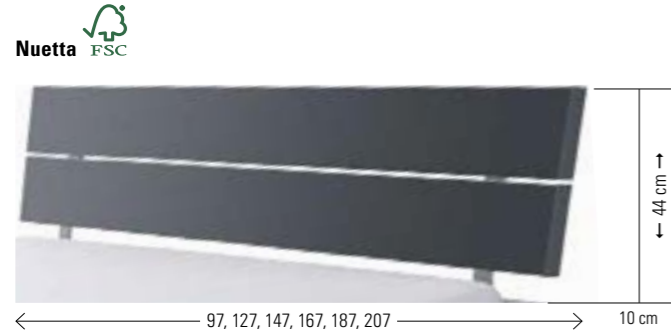

Dimension: 90/100, 120, 140, 160, 180, 200



Dimension: 140, 160, 180, 200

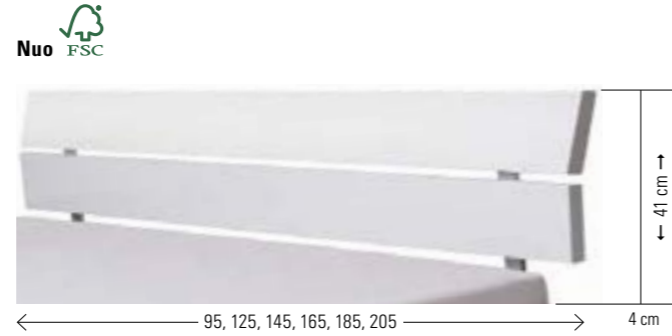

Dimension: 90/100, 120, 140, 160, 180, 200



Dimension: 90/100, 120, 140, 160, 180, 200

Höhe Kopfteile: In Anwendung mit Soft-Line Noble 14 + 2 cm | hauteur têtes: En utilisation avec Soft-Line Noble 14 + 2 cm | height headboards: In application with Soft-Line Noble 14 + 2 cm



**Gepolsterte Kopfteile, Wandpaneele, Stoffauswahl/Farben siehe Register 1, Lampen siehe Register 2.**

Têtes de lits rembourrées, panneaux muraux, choix de tissus/couleurs voir registre 1, lampes voir registre 2.  
Upholstered headboards, wallpanels, choice of tissues/colours see index 1, lamps see index 2.

Kopfteile   têtes de lit   headboards	Holzfarben   couleurs bois   colours wood							
	10	16	30	35	49	50	55	59
Nuetta	●	●	●	●	●	●	●	●
Nuo	●	●	●	●	●	●	●	●
Orva	●	●	●	●	●	●	●	●
Spyd	●	●	●	●	●	●	●	●

## Adapter | adaptateur | adapter

Bei hohen Matratzen kann mit dem Verlängerungsadapter das Kopfteil um 9 oder 13 cm erhöht werden.

La tête de lit peut être rehaussée de 9 ou 13 cm avec l'adaptateur quand le matelas est plus épais. With the extension adapter the headboard can be extended 9 or 13 cm if mattresses are high.

Head-Plus  
Metall | métal | metal

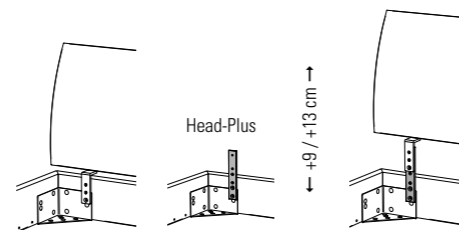

# Kissen zu Kopfteilen | coussins pour têtes de lit | cushions for headboards



**Befestigung mit 2 Bändern (Klettverschluss)**  
Fixation avec 2 bandes (Velcro®)  
Fixation with 2 ribbons (Velcro® fastener)

**Stoffauswahl/Farben für Kissen siehe Register 1, Seiten 8–9**  
Choix de tissus/couleurs pour coussins voir registre 1, pages 8–9  
Choice of tissues/colours for cushions see index 1, pages 8–9

Kissen   coussins   cushions	Effektive Masse cm dimensions effectives cm effective dimensions cm	zu Kopfteilen pour têtes de lit for headboards		Breitenmasse cm dimensions de largeur cm widths dimensions cm
		Nuetta	Orva	
Arona	86, 116, 136, 156, 176×3,5×25	●		90/100, 120, 140, 160, 180/200
Lumo	86, 116, 136, 156, 176×6×25	●		90/100, 120, 140, 160, 180/200
Ravo	80, 110, 130, 150, 170, 190×3,5×35	●	●	90/100, 120, 140, 160, 180, 200
Suny (2er Set   set de 2   set of 2)	55×6×40	●	●	
Varo (2er Set   set de 2   set of 2)	55×10×35		●	

## Ausführungen | exécutions | executions

### Holz | bois | wood

<b>10 Weiss</b> Blanc White	<b>16 Anthracit</b>	<b>30 Walnuss</b> Noyer Walnut	<b>35 Hochglanz weiss</b> Blanc brillant White highgloss	<b>49 Beton Nachbildung</b> Béton laminé Concrete laminated	<b>50 Eiche sägerauh natur</b> Chêne brut de sciage naturel Oak rough sawn natural
<b>55 Esche hell</b> Frêne clair Ash light	<b>59 Buche</b> Hêtre Beech				

Die Holzstrukturen sind Nachbildungen. | Les structures bois sont en bois laminé. | The wood structures are laminated.

## Nachttische, Kommoden | tables de nuit, commodes | bedside tables, chests of drawers

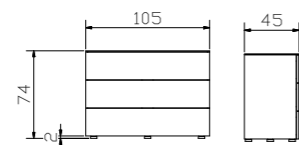
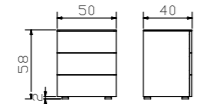
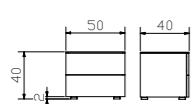

**Standardmässig werden Nachttische und Kommoden mit Sockelfüssen alufarbig geliefert.**  
Livraison standard des tables de nuits et commodes avec pieds teinté alu.  
Bedside tables and chests of drawers supplied in standard version with base legs alucoloured.

### Ausführungen | exécutions | executions

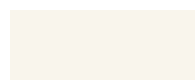

**10 Weiss**  
Blanc  
White



**16 Anthracit**



**30 Walnuss**  
Noyer  
Walnut



**35 Hochglanz weiss**  
Blanc brillant  
White highgloss



**49 Beton Nachbildung**  
Béton laminé  
Concrete laminated

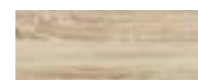

**50 Eiche sägerauh natur**  
Chêne brut de sciage naturel  
Oak rough sawn natural



**55 Esche hell**  
Frêne clair  
Ash light



**59 Buche**  
Hêtre  
Beech

**Die Holzstrukturen sind Nachbildungen.** | Les structures bois sont en bois laminé. |  
The wood structures are laminated.

### Nachttisch | table de nuit | bedside table

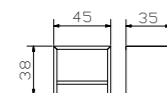

**10**



**16**



**50**



**59**

**Inklusive Eck-Dekos in alu und chrom**  
décors angles en alu et chrome inclus  
including deco corners in alu and chrome

### Herrendiener | valet | dressboy

**Emilio** alu, chrom

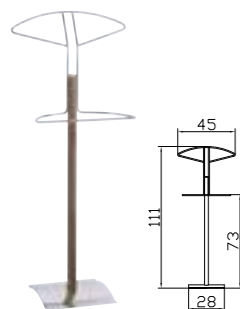

**10**



**16**



**30**

## Zubehör | accessoires | accessories

weiteres Zubehör siehe Register 2 | autres accessoires voir registre 2 | further accessories see index 2

### Bedienungskomfort | facilité d'utilisation | ease of use



#### TipOn-Blumotion

Ausgewählte Beimöbel unserer Movie-/Soft-/Top-Line verfügen über die mechanische Öffnungsunterstützung.  
Une sélection d'accessoires de notre gamme Movie-/Soft-/Top-Line se distinguent par le support d'ouverture mécanique.  
Selected accessories from our Movie-/Soft-/Top-Line feature the mechanical.



#### Anleitung zu TipOn-Blumotion auf YouTube

Tutoriel TipOn-Blumotion sur YouTube  
TipOn-Blumotion tutorial on YouTube

### Füsse | pieds | feet

#### Option zu | pour | for Mino, Triore, Viola



**Sima 10/20**  
weiss, blanc, white  
Nussbaum, noyer, walnut

**Leg 8**  
alu, chrom, inox

**Piedo 8**  
alu, chrom

**Roll 8**  
alu, chrom

**Jone 10**  
anthracit, white,  
used

**Tindo 10**  
alu, anthracit,  
bronze, copper



**Fuss Set (4 Stk.)** | set de pieds (4 pcs) | set of feet (4 pcs)

### Ausführungen | exécutions | executions

#### Metall | métal | metal



**00 Chrom**



**04 Used**



**16 Anthracit**



**40 Bronze**



**41 Copper**



**42 Alu**



**43 Inox**



**45 Iron**

**Chrom = Metall verchromt** | métal chromé | metal chrome-plated

**Used = Metall galvanisiert** | métal galvanisé | metal galvanised

**Anthracit = Metall pulverbeschichtet** | métal thermolaqué | metal powder-coated

**Bronze = Metall lackiert** | métal laqué | metal lacquered

**Copper = Metall lackiert** | métal laqué | metal lacquered

**Alu = Metall pulverbeschichtet** | métal thermolaqué | metal powder-coated

**Inox = Edelstahl gebürstet** | acier inoxydable brossé | stainless steel brushed

**Iron = Metall geflammt, pulverbeschichtet** | métal flammé, thermolaqué |  
metal mottled, powder-coated





**Dimension cm**

<b>Mino</b>	Nachttisch	table de nuit	bedside table	50/40/40
<b>Viola</b>	Kommode	commode	chest of drawers	105/45/74

**Dimension cm**

<b>Star 16</b>	Rahmen Breiten Längen	cadre largeurs longueurs	frame widths lengths	90, 100, 120, 140, 160, 180, 200 190, 200, 210, 220
<b>Mico chrom</b>	Füße Höhen	pieds hauteurs	feet heights	20, 25, 30
<b>Orva Varo</b>	Kopfteil Kissen (2er Set) Alpina lightgrey 390	tête de lit coussins (set de 2) Alpina lightgrey 390	headboard cushions (set of 2) Alpina lightgrey 390	140, 160, 180, 200 55/10/35

**Alle Holzteile in Hochglanz weiss** | toutes les parties en bois en blanc brillant | all wooden parts in white highgloss

**Lampen und weitere Beimöbel siehe Register 2** | lampes et autres accessoires voir registre 2 | lamps and further accessories see index 2

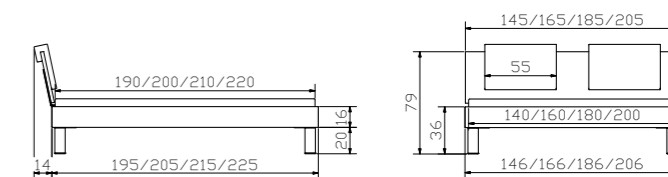



	Dimension cm			
<b>Lovie-Box</b>	1 Bettkasten Breiten	1 tiroir de lit largeurs	1 bed drawer widths	90, 100, 120, 140
	2 Bettkästen Breiten	2 tiroirs de lit largeurs	2 bed drawers widths	140, 160, 180, 200
	Höhe	hauteur	height	25

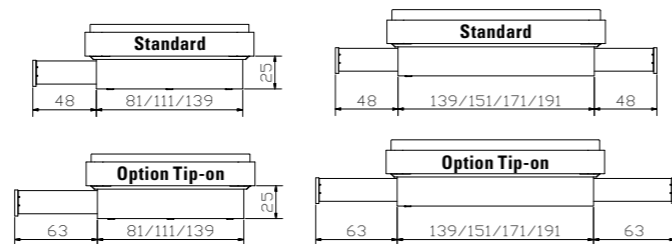

	Dimension cm			
<b>Star 16</b>	Rahmen Breiten Längen	cadre largeurs longueurs	frame widths lengths	90, 100, 120, 140, 160, 180, 200 190, 200, 210, 220
<b>Tondo alu</b>	Füsse Höhen	pieds hauteurs	feet heights	20
<b>Malta</b>	Kopfteil, Shine stone 685	tête de lit, Shine stone 685	headboard, Shine stone 685	120, 140, 160, 180, 200
<b>Mino</b>	Nachttisch	table de nuit	bedside table	50/40/40

**Alle Holzteile in weiss** | toutes les parties en bois en blanc | all wooden parts in white  
**Weitere Beimöbel siehe Register 2** | autres accessoires voir registre 2 | further accessories see index 2

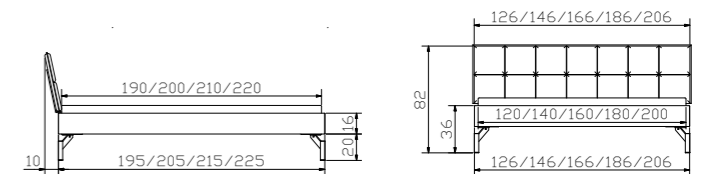



				Dimension cm
<b>Pero</b>	Nachttisch	table de nuit	bedside table	45/35/38
<b>Roll-Box 20</b>	Bettkasten, weiss	tiroir de lit, blanc	bed drawer, white	137/67/19

				Dimension cm
<b>Star 16</b>	Rahmen Breiten Längen	cadre largeurs longueurs	frame widths lengths	90, 100, 120, 140, 160, 180, 200 190, 200, 210, 220
<b>Indus iron</b>	Kufen Breiten Höhen	patins largeurs hauteurs	vats widths heights	140, 160, 180, 200 20, 25
<b>Orva Varo</b>	Kopfteil Kissen (2er Set), Casual olive 333	tête de lit coussins (set de 2), Casual olive 333	headboard cushions (set of 2), Casual olive 333	140, 160, 180, 200 55/10/35

**Alle Holzteile in Eiche sägerauh natur oder weiss** | toutes les parties en bois en chêne brut de sciage naturel ou blanc | all wooden parts in oak rough sawn natural or white  
**Weitere Beimöbel siehe Register 2** | autres accessoires voir registre 2 | further accessories see index 2

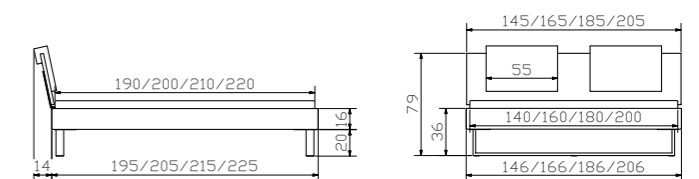



				Dimension cm
<b>Mino</b>	Nachttisch	table de nuit	bedside table	50/40/40

				Dimension cm
<b>Star 16</b>	Rahmen Breiten Längen	cadre largeurs longueurs	frame widths lengths	90, 100, 120, 140, 160, 180, 200 190, 200, 210, 220
<b>Vegas</b>	Füße Höhe	pieds hauteur	feet height	16
<b>Nuo</b>	Kopfteil	tête de lit	headboard	90/100, 120, 140, 160, 180, 200

Alle Holzteile in Beton Nachbildung | toutes les parties en beton laminé | all wooden parts in concrete laminated  
 Weitere Beimöbel siehe Register 2 | autres accessoires voir registre 2 | further accessories see index 2

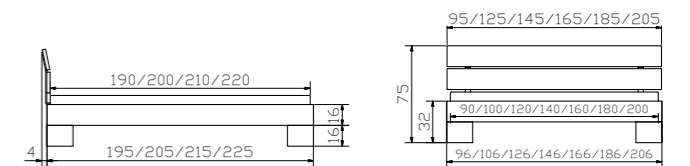



				Dimension cm
<b>Viola</b>	Kommode	commode	chest of drawers	105/45/74
<b>Pero</b>	Nachttisch	table de nuit	bedside table	45/35/38

				Dimension cm
<b>Star 16</b>	Rahmen Breiten Längen	cadre largeurs longueurs	frame widths lengths	90, 100, 120, 140, 160, 180, 200 190, 200, 210, 220
<b>Juve</b>	Füsse, Buche natur Höhen	pieds, hêtre naturel hauteurs	feet, natural beech heights	20, 25
<b>Orva Sunny</b>	Kopfteil Kissen (2er Set) Kunstleder white 301	tête de lit coussins (set de 2) cuir synthétique white 301	headboard cushions (set of 2) synthetic leather white 301	140, 160, 180, 200 55/6/40

**Alle Holzteile in Buche oder weiss** | toutes les parties en hêtre ou blanc | all wooden parts in beech or white  
**Weitere Beimöbel siehe Register 2** | autres accessoires voir registre 2 | further accessories see index 2

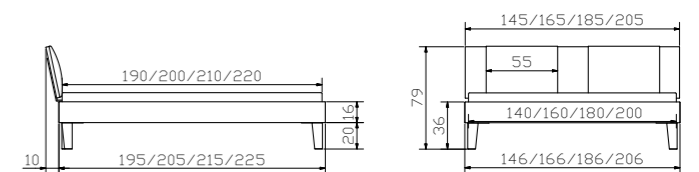



				Dimension cm
<b>Viola</b>	Kommode	commode	chest of drawers	105/45/82
<b>Leg chrom</b>	Füße	pieds	feet	
<b>Mino</b>	Nachttisch	table de nuit	bedside table	50/40/48
<b>Leg chrom</b>	Füße	pieds	feet	

				Dimension cm
<b>Advance 18</b>	Rahmen Breiten Längen	cadre largeurs longueurs	frame widths lengths	90, 100, 120, 140, 160, 180, 200 190, 200, 210, 220
<b>Gina chrom</b>	Füße Höhen	pieds hauteurs	feet heights	20
<b>Sogno L</b>	Wandpaneel Kitana anthrazit 604 siehe Register 1	panneau mural Kitana anthrazit 604 voir registre 1	wall panel Kitana anthrazit 604 see index 1	161, 181, 201, 221

Alle Holzteile in Walnuss | toutes les parties en bois en noyer | all wooden parts in walnut  
 Weitere Beimöbel siehe Register 2 | autres accessoires voir registre 2 | further accessories see index 2

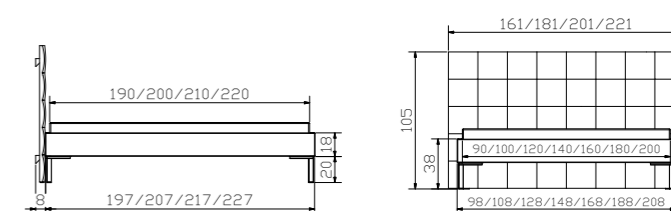



**Alle Holzteile in weiss** | toutes les parties en bois en blanc | all wooden parts in white  
**Weitere Beimöbel siehe Register 2** | autres accessoires voir registre 2 | further accessories see index 2



**Curty**

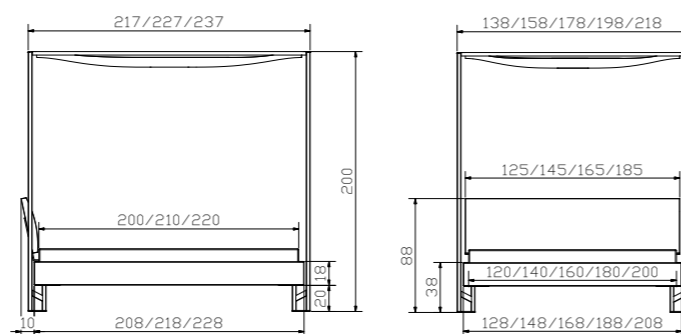

				<b>Dimension cm</b>
<b>Advance 18</b>	Rahmen Breiten Längen	cadre largeurs longueurs	frame widths lengths	90, 100, 120, 140, 160, 180, 200 190, 200, 210, 220
<b>Cielo white</b>	Baldachin Breiten Höhen	baldaquin largeurs hauteurs	canopy widths heights	120, 140, 160, 180, 200 20
<b>Lecco</b>	Kopfteil, Campos blanc 372 siehe Register 1	tête de lit, Campos blanc 372 voir registre 1	headboard, Campos blanc 372 see index 1	90/100, 120, 140, 160, 180/200
<b>Vela</b>	Baldachin-Tuch, Baumwolle weiss Breiten Länge	tissu de baldaquin, coton blanc largeurs longueur	Canopy cloth, cotton white widths length	120, 140, 160, 180 200
<b>Triore</b>	Nachttisch	table de nuit	bedside table	50/40/58
<b>Emilio alu</b>	Herrendiener	valet	dressboy	45/28/111



				Dimension cm
<b>Viola</b>	Kommode	commode	chest of drawers	105/45/74
<b>Mino</b>	Nachttisch	table de nuit	bedside table	50/40/40

				Dimension cm
<b>Advance 18</b>	Rahmen Breiten Längen	cadre largeurs longueurs	frame widths lengths	90, 100, 120, 140, 160, 180, 200 190 (200), 200 (210), 210 (220)
<b>Quada anthracit</b>	Füße Höhen	pieds hauteurs	feet heights	20, 25
<b>Cena</b>	Kopfteil, Campos blanc 372 hat Einfluss auf Bettlänge siehe Register 1 Seite 4	tête de lit, Campos blanc 372 a un impact sur la longueur du lit voir registre 1 page 4	headboard, Campos blanc 372 affects the length of bed see index 1 page 4	90, 100, 120, 140, 160, 180, 200 90–120 = 1 Kissen/coussin/ cushion

**Alle Holzteile in Weiss oder Eiche sägerauh natur** | toutes les parties en bois en blanc ou hêne brut de sciage naturel | all wooden parts in white or oak rough sawn natural

**Weitere Beimöbel siehe Register 2** | autres accessoires voir registre 2 | further accessories see index 2

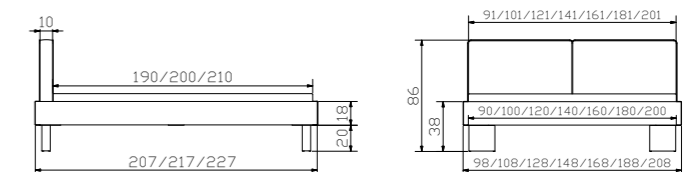



				Dimension cm
<b>Mino</b>	Nachttisch	table de nuit	bedside table	50/40/40
<b>Roll-Box 20</b>	Bettkasten, weiss	tiroir de lit, blanc	bed drawer, white	137/67/19

				Dimension cm
<b>Advance 18</b>	Rahmen Breiten Längen	cadre largeurs longueurs	frame widths lengths	90, 100, 120, 140, 160, 180, 200 190, 200, 210, 220
<b>Road used</b>	Füsse fixiert Rollen nur optisch Höhe	pieds fixes roulettes uniquement décoration hauteur	feet fixed castors only visual height	20
<b>Orva Ravo</b>	Kopfteil Kissen, Alpina anthrazit 391	tête de lit coussin, Alpina anthrazit 391	headboard cushion, Alpina anthrazit 391	140, 160, 180, 200 140, 160, 180, 200

**Alle Holzteile in Eiche sägerauh natur oder weiss** | toutes les parties en bois en chêne brut de sciage naturel ou blanc | all wooden parts in oak rough sawn natural or white  
**Weitere Beimöbel siehe Register 2** | autres accessoires voir registre 2 | further accessories see index 2

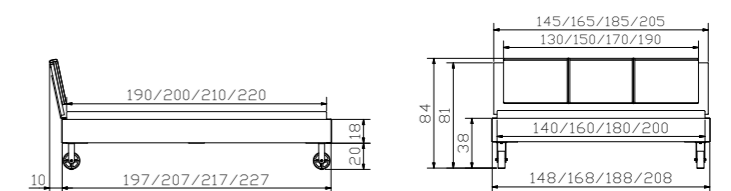



				Dimension cm
<b>Topa</b> copper	Bank inkl. Kissen Casual carbon 334	banquette, coussin incl. Casual carbon 334	bench, cushion incl. Casual carbon 334	144/44/38
<b>Mino</b>	Nachttisch	table de nuit	bedside table	50/40/48
<b>Tindo 10</b> copper	Füße	pieds	feet	
<b>Viola</b>	Kommode	commode	chest of drawers	105/45/74

				Dimension cm
<b>Advanced 18</b>	Rahmen Breiten Längen	cadre largeurs longueurs	frame widths lengths	90, 100, 120, 140, 160, 180, 200 190, 200, 210, 220
<b>Tondo</b> copper	Füße Höhe	pieds hauteur	feet height	20
<b>Cussina</b>	Kopfteil, Casual carbon 334 siehe Register 1	tête de lit, Casual carbon 334 voir registre 1	headboard, Casual carbon 334 see index 1	140, 160, 180, 200

**Alle Holzteile in anthrazit** | toutes les parties en bois en anthracite | all wooden parts in anthracite  
**Weitere Beimöbel siehe Register 2** | autres accessoires voir registre 2 | further accessories see index 2

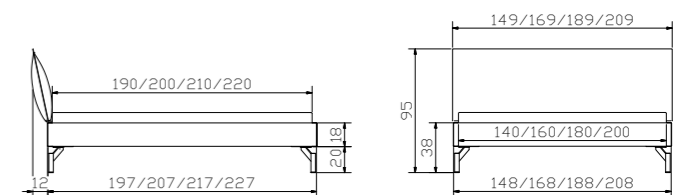



**Dimension cm**

<b>Advance 18</b>	Rahmen Breiten Längen	cadre largeurs longueurs	frame widths lengths	90, 100, 120, 140, 160, 180, 200 190, 200, 210, 220
<b>Indus anthracit</b>	Kufen Breiten Höhen	patins largeurs hauteurs	vats widths heights	140, 160, 180, 200 20, 25
<b>Cussina</b>	Kopfteil, Ranch stone 660 siehe Register 1	tête de lit, Ranch stone 660 voir registre 1	headboard, Ranch stone 660 see index 1	140, 160, 180, 200
<b>Mino</b>	Nachttisch	table de nuit	bedside table	50/40/40

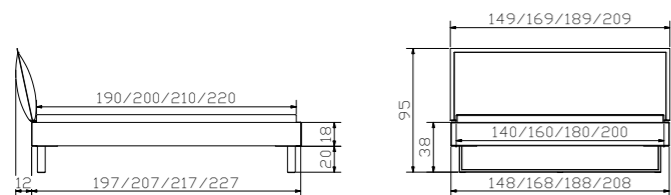

**Alle Holzteile in Anthracit** | toutes les parties en bois en anthracite | all wooden parts in anthracite  
**Weitere Beimöbel siehe Register 2** | autres accessoires voir registre 2 | further accessories see index 2

**Dimension cm**

<b>Advanced 18</b>	Rahmen Breiten Längen	cadre largeurs longueurs	frame widths lengths	90, 100, 120, 140, 160, 180, 200 190, 200, 210, 220
<b>Mico anthracit</b>	Füße Höhen	pieds hauteurs	feet heights	10, 20, 25, 30
<b>Nuetta</b>	Kopfteil	tête de lit	headboard	90/100, 120, 140, 160, 180, 200
<b>Tree</b>	Nachttisch	table de nuit	bedside table	Ø 42/44

**Alle Holzteile in Beton Nachbildung** | toutes les parties en bois en béton laminé | all wooden parts in concrete laminated

**Tree Echtbeton** | Tree béton véritable | Tree real concrete

**Weitere Beimöbel siehe Register 2** | autres accessoires voir registre 2 | further accessories see index 2

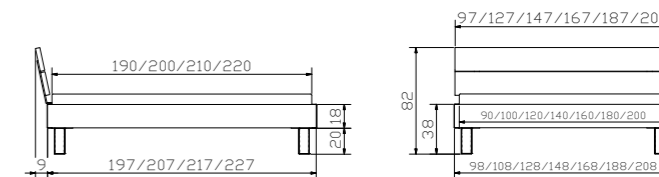



				Dimension cm
<b>Topa</b> anthracit	Bank inkl Kissen Shine musk 683	banquette, coussin incl. Shine musk 683	bench, cushion incl. Shine musk 683	144/44/38
<b>Mino</b>	Nachttisch	table de nuit	bedside table	50/40/40

				Dimension cm
<b>Advance 18</b>	Rahmen Breiten Längen	cadre largeurs longueurs	frame widths lengths	90, 100, 120, 140, 160, 180, 200 190, 200, 210, 220
<b>Slid</b> anthracit	Füße Breiten Höhen	pieds largeurs hauteurs	feet widths heights	140, 160, 180, 200 20, 25
<b>Lecco</b>	Kopfteil, Shine musk 683 siehe Register 1	tête de lit, Shine musk 683 voir registre 1	headboard, Shine musk 683 see index 1	90/100, 120, 140, 160, 180/200

**Alle Holzteile in Beton Nachbildung** | toutes les parties en bois en béton laminé | all wooden parts in concrete laminated  
**Weitere Beimöbel siehe Register 2** | autres accessoires voir registre 2 | further accessories see index 2

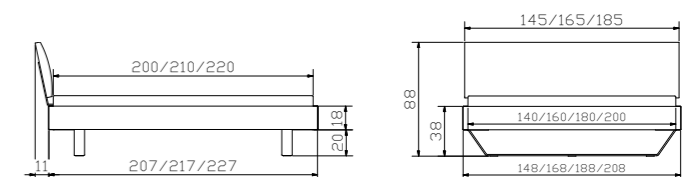



	Dimension cm			
<b>Lovie-Box</b>	1 Bettkasten Breiten 2 Bettkästen Breiten Höhe	1 tiroir de lit largeurs 2 tiroirs de lit largeurs hauteur	1 bed drawer widths 2 bed drawers widths height	90, 100, 120, 140  140, 160, 180, 200 25

	Dimension cm			
<b>Advance 18</b>	Rahmen Breiten Längen	cadre largeurs longueurs	frame widths lengths	90, 100, 120, 140, 160, 180, 200 190, 200, 210, 220
<b>Cantu</b>	Füsse Höhen	pieds hauteurs	feet heights	20, 25, 30
<b>Orva</b>	Kopfteil	tête de lit	headboard	140, 160, 180, 200
<b>Viola</b>	Kommode	commode	chest of drawers	105/45/74
<b>Mino</b>	Nachttisch	table de nuit	bedside table	50/40/40
<b>Snake alu</b>	Lampen (2er Set) 12V DC, 6 LED 3 Beleuchtungsarten	lampes (set de 2) 12V DC, 6 LED 3 différentes illuminations	lamps (set of 2) 12V DC, 6 LED 3 different illuminations	

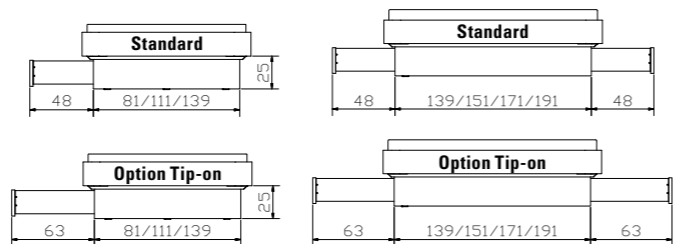

**Alle Holzteile in weiss oder Esche hell** | toutes les parties en bois en blanc ou frêne clair | all wooden parts in white or ash light

**Lampen und weitere Beilmöbel siehe Register 2** | lampes et autres accessoires voir registre 2 | lamps and further accessories see index 2

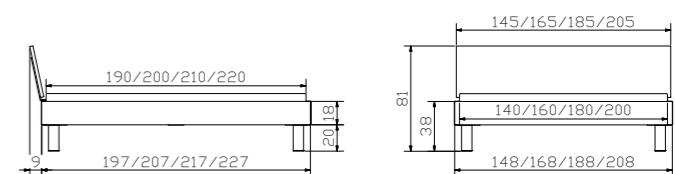



				Dimension cm
<b>Nuetta</b>	Kopfteil	tête de lit	headboard	90/100, 120, 140, 160, 180, 200
<b>Snake</b> alu	Lampen (2er Set) 12V DC, 6 LED 3 Beleuchtungsarten	lampes (set de 2) 12V DC, 6 LED 3 différent illuminations	lamps (set of 2) 12V DC, 6 LED 3 different illuminations	
<b>Boga</b>	Kopfteil, Alpina navy 393 siehe Register 1	tête de lit, Alpina navy 393 voir registre 1	headboard, Alpina navy 393 see index 1	90, 100, 120, 140, 160, 180, 200
<b>Ablo</b> alu	Nachttisch, Glas/alu	table de nuit, verre/alu	bedside table, glass/alu	Ø 40

				Dimension cm
<b>Advance 18</b>	Rahmen Breiten Längen	cadre largeurs longueurs	frame widths lengths	90, 100, 120, 140, 160, 180, 200 190, 200, 210, 220
<b>Cantu</b>	Füße Höhen	pieds hauteurs	feet heights	20, 25, 30
<b>Malta</b>	Kopfteil, Casual olive 333 siehe Register 1	tête de lit, Casual olive 333 voir registre 1	headboard, Casual olive 333 see index 1	120, 140, 160, 180, 200
<b>Ablo</b> alu	Nachttisch, Glas/alu	table de nuit, verre/alu	bedside table, glass/alu	Ø 40

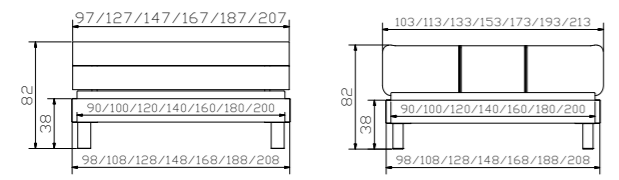

**Alle Holzteile in Esche hell** | toutes les parties en bois en frêne clair | all wooden parts in ash light  
**Lampen und weitere Beimöbel siehe Register 2** | lampes et autres accessoires voir registre 2 | lamps and further accessories see index 2

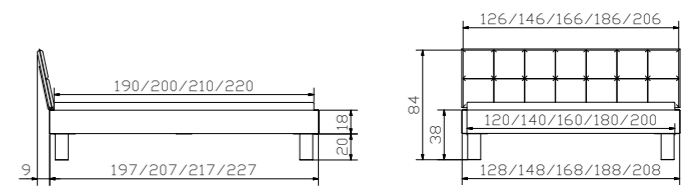



				Dimension cm
<b>Mino</b>	Nachttisch	table de nuit	bedside table	50/40/40

				Dimension cm
<b>Noble 14</b>	Rahmen Breiten Längen	cadre largeurs longueurs	frame widths lengths	90, 100, 120, 140, 160, 180, 200 190, 200, 210, 220
<b>Caro alu</b>	Füße Höhen	pieds hauteurs	feet heights	10, 20, 25
<b>Lenio</b>	Kopfteil, Ranch jeans 662 siehe Register 1	tête de lit, Ranch jeans 662 voir registre 1	headboard, Ranch jeans 662 see index 1	90/100, 120, 140, 160, 180, 200

**Alle Holzteile in weiss** | toutes les parties en bois en blanc | all wooden parts in white  
**Weitere Beimöbel siehe Register 2** | autres accessoires voir registre 2 | further accessories see index 2

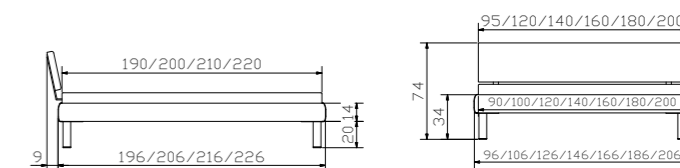



**Dimension cm**

<b>Orva</b>	Kopfteil	tête de lit	headboard	140, 160, 180, 200
<b>Ravo</b>	Kissen, Kitana aqua 603	coussin, Kitana aqua 603	cushion, Kitana aqua 603	140, 160, 180, 200
<b>Nuetta</b>	Kopfteil	tête de lit	headboard	90/100, 120, 140, 160, 180, 200
<b>Lumo</b>	Kissen, Kitana aqua 603	coussin, Kitana aqua 603	cushion, Kitana aqua 603	90/100, 120, 140, 160, 180/200

**Dimension cm**

<b>Noble 14</b>	Rahmen Breiten Längen	cadre largeurs longueurs	frame widths lengths	90, 100, 120, 140, 160, 180, 200 190, 200, 210, 220
<b>Masi</b>	Füsse Höhen	pieds hauteurs	feet heights	20, 25
<b>Boga</b>	Kopfteil, Alpina lightgrey 390 siehe Register 1	tête de lit, Alpina lightgrey 390 voir registre 1	headboard, Alpina lightgrey 390 see index 1	90, 100, 120, 140, 160, 180, 200
<b>Aska</b>	Sekretär	secrétaire	bureau	120/60/85
<b>Circo 44</b>	Nachttisch/Hocker	table de nuit/tabouret	bedside table/stool	Ø 45/44
<b>Mino</b>	Nachttisch	table de nuit	bedside table	50/40/40

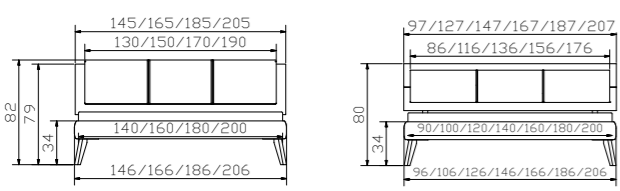

**Alle Holzteile in weiss** | toutes les parties en bois en blanc | all wooden parts in white  
**Weitere Beimöbel siehe Register 2** | autres accessoires voir registre 2 | further accessories see index 2

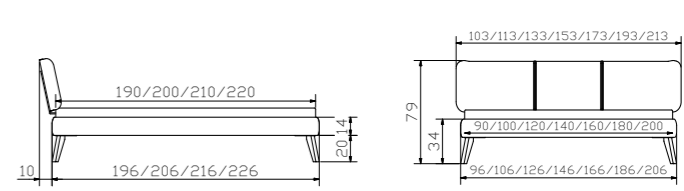



				Dimension cm
<b>Nuo</b>	Kopfteil	tête de lit	headboard	90/100, 120, 140, 160, 180, 200
<b>Ablo</b> alu	Nachttisch, Glas/alu	table de nuit, verre/alu	bedside table, glass/alu	Ø 40
<b>Orva</b>	Kopfteil	tête de lit	headboard	140, 160, 180, 200
<b>Varo</b>	Kissen (2er Set) Ranch indigo 663	coussins (set de 2) Ranch indigo 663	cushions (set of 2) Ranch indigo 663	55/10/35

				Dimension cm
<b>Noble 14</b>	Rahmen Breiten Längen	cadre largeurs longueurs	frame widths lengths	90, 100, 120, 140, 160, 180, 200 190, 200, 210, 220
<b>Juve</b>	Füße Höhen	pieds hauteurs	feet heights	20, 25
<b>Spyd</b>	Kopfteil	tête de lit	headboard	90/100, 120, 140, 160, 180, 200
<b>Snake</b> alu	Lampen (2er Set) 12V DC, 6 LED 3 Beleuchtungsarten	lamps (set de 2) 12V DC, 6 LED 3 différent illuminations	lamps (set of 2) 12V DC, 6 LED 3 different illuminations	
<b>Pero</b>	Nachttisch	table de nuit	bedside table	45/35/38
<b>Viola</b>	Kommode	commode	chest of drawers	105/45/74

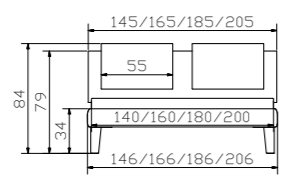
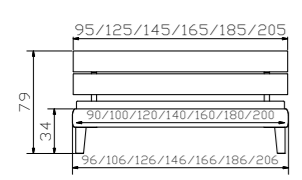

**Alle Holzteile in weiss** | toutes les parties en bois en blanc | all wooden parts in white  
**Weitere Lampen + Beimöbel siehe Register 2** | autres lampes et accessoires voir registre 2 | further lamps and accessories see index 2

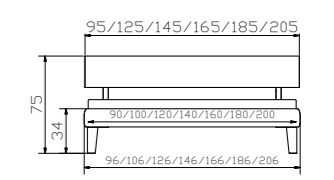
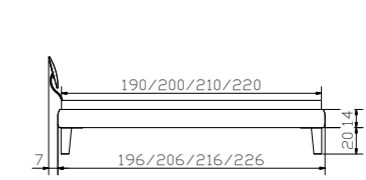



				Dimension cm
<b>Viola</b>	Kommode	commode	chest of drawers	105/45/74
<b>Pero</b>	Nachttisch	table de nuit	bedside table	45/35/38

				Dimension cm
<b>Noble 14</b>	Rahmen Breiten Längen	cadre largeurs longueurs	frame widths lengths	90, 100, 120, 140, 160, 180, 200 190, 200, 210, 220
<b>Ivio</b>	Füße Höhen	pieds hauteurs	feet heights	10, 20, 25
<b>Ronna</b>	Kopfteil, Kitana grigio 602 siehe Register 1	tête de lit, Kitana grigio 602 voir registre 1	headboard, Kitana grigio 602 see index 1	90/100, 120, 140, 160, 180, 200

**Alle Holzteile in Eiche sägerauh natur** | toutes les parties en bois en chêne brut de sciage naturel | all wooden parts in oak rough sawn natural  
**Weitere Beimöbel siehe Register 2** | autres accessoires voir registre 2 | further accessories see index 2

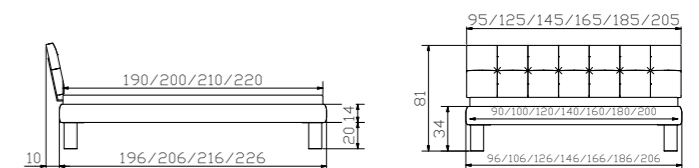

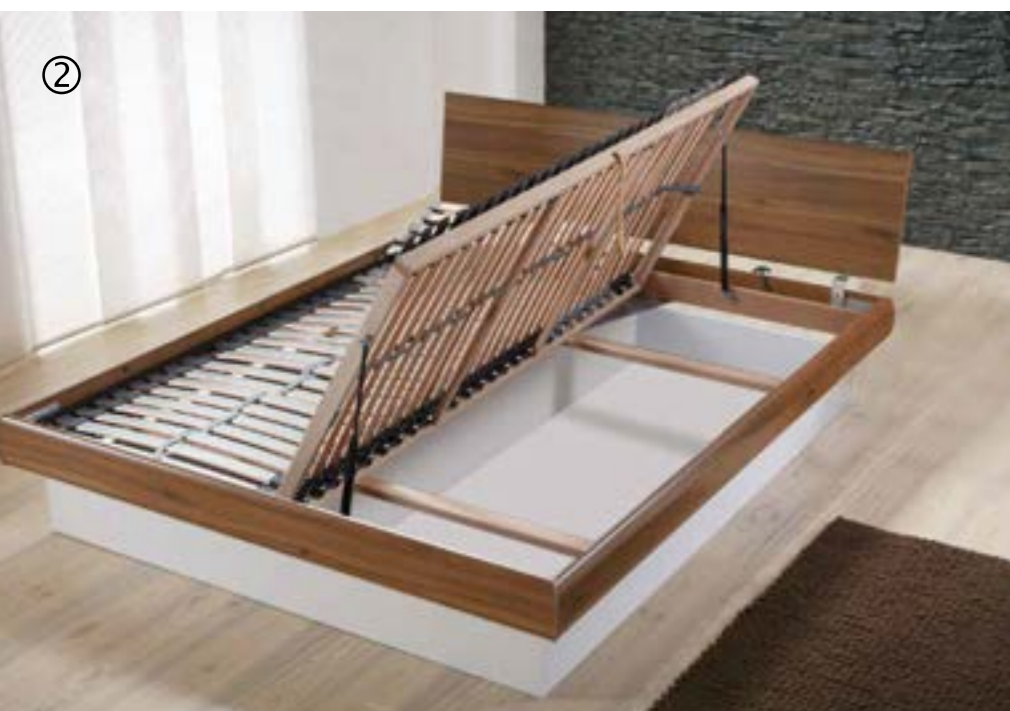

① <b>Ultrafree-Lift KF</b>	Lattenrost	sommier	slats
② <b>Econom-move</b>	Lattenrost	sommier	slats
	Details siehe Seite 3.9	détails voir page 3.9	details see page 3.9

				Dimension cm
<b>Noble 14</b>	Rahmen Breiten Längen	cadre largeurs longueurs	frame widths lengths	90, 100, 120, 140, 160, 180, 200 190, 200, 210, 220
<b>Practico-Box</b>	Weiss Breiten Längen Höhe	blanc largeurs longueurs hauteur	white widths lengths height	90, 100, 120, 140, 160, 180, 200 200, 210, 220 25
<b>Gabo</b>	Kopfteil, Campos blanc 372 siehe Register 1	tête de lit, Campos blanc 372 voir registre 1	headboard, Campos blanc 372 see index 1	90, 100, 120, 140, 160, 180, 200
<b>Triore</b>	Nachttisch	table de nuit	bedside table	50/40/58

Alle Holzteile in Walnuss, weiss oder Eiche sägerauh natur | toutes les parties en bois en noyer, blanc ou chêne brut de sciage naturel | all wooden parts in walnut, white or oak rough sawn natural

Weitere Beimöbel siehe Register 2 | autres accessoires voir registre 2 | further accessories see index 2

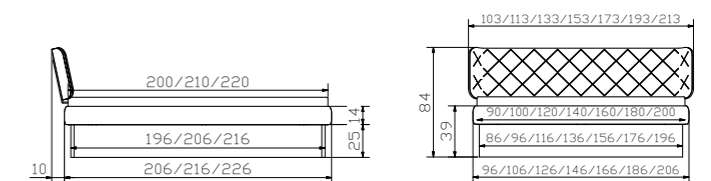

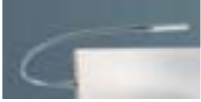

				Dimension cm
<b>Study</b>	Schreibtisch	bureau	desk	160/80/75
<b>Triore</b>	Nachttisch/Container	table de nuit/caisson	bedside table/container	50/40/58
<b>Ablo chrom</b>	Nachttisch, Glas/chrom	table de nuit, verre/chrome	bedside table, glass/chrome	Ø 40
<b>Emilio chrom</b>	Herrendiener	valet	dressboy	45/28/111
<b>Roll-Box 20</b>	Bettkasten	tiroir de lit	bed drawer	137/67/19
<b>Boa chrom</b>	Lampen (2er Set) 12V DC, 12 LED warm	lampes (set de 2) 12V DC, 12 LED warm	lamps (set of 2) 12V DC, 12 LED warm	

**Alle Holzteile in Esche hell oder weiss** | toutes les parties en bois en frêne clair ou blanc | all wooden parts in ash light or white  
**Lampen und weitere Beimöbel siehe Register 2** | lampes et autres accessoires voir registre 2 | lamps and further accessories see index 2

				Dimension cm
<b>Noble 14</b>	Rahmen Breiten Längen	cadre largeurs longueurs	frame widths lengths	90, 100, 120, 140, 160, 180, 200 190, 200, 210, 220
<b>Jump</b>	Füsse, chromfarbig Höhe	pieds, teinté chrome hauteur	feet, chrome coloured height	20
<b>Lecco</b>	Kopfteil Kunstleder white 301 siehe Register 1	tête de lit cuir synthétique white 301 voir registre 1	headboard synthetic leather white 301 see index 1	90/100, 120, 140, 160, 180/200

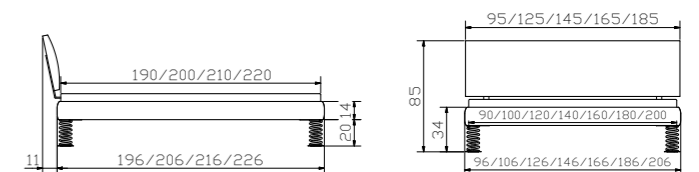



				Dimension cm
<b>Viola</b>	Kommode	commode	chest of drawers	105/45/74
<b>Mino</b>	Nachttisch	table de nuit	bedside table	50/40/40

				Dimension cm
<b>Noble 14</b>	Rahmen Breiten Längen	cadre largeurs longueurs	frame widths lengths	90, 100, 120, 140, 160, 180, 200 190, 200, 210, 220
<b>Cantu</b>	Füße Höhen	pieds hauteurs	feet heights	20, 25, 30
<b>Nuetta</b>	Kopfteil	tête de lit	headboard	90/100, 120, 140, 160, 180, 200
<b>Arona</b>	Kissen, Alpina lightgrey 390	coussin, Alpina lightgrey 390	cushion, Alpina lightgrey 390	90/100, 120, 140, 160, 180/200

**Alle Holzteile in Buche** | toutes les parties en bois en hêtre | all wooden parts in beech  
**Weitere Beimöbel siehe Register 2** | autres accessoires voir registre 2 | further accessories see index 2

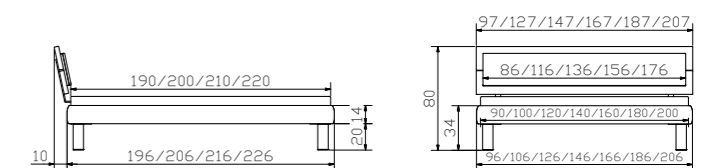



				Dimension cm
<b>Ablo</b> chrom	Nachttisch, Glas/chrom	table de nuit, verre/chrome	bedside table, glass/chrome	Ø 40

				Dimension cm
<b>Noble 14</b>	Rahmen Breiten Längen	cadre largeurs longueurs	frame widths lengths	90, 100, 120, 140, 160, 180, 200 190, 200, 210, 220
<b>Fasio</b> bronze	Füsse Höhen	pieds hauteurs	feet heights	20
<b>Ripo</b>	Kopfteil, Shine opal 682 siehe Register 1	tête de lit, Shine opal 682 voir registre 1	headboard, Shine opal 682 see index 1	90, 100, 120, 140, 160, 180, 200

**Alle Holzteile in Walnuss** | toutes les parties en bois en noyer | all wooden parts in walnut  
**Weitere Beimöbel siehe Register 2** | autres accessoires voir registre 2 | further accessories see index 2

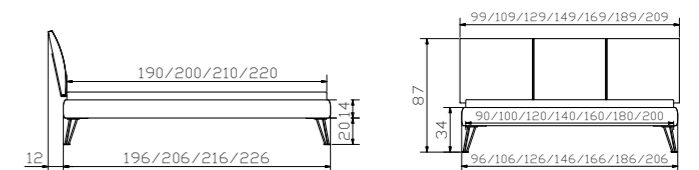

# Prestige 18



				Dimension cm
<b>Viola</b>	Kommode	commode	chest of drawers	105/45/74
<b>Mino</b>	Nachttisch	table de nuit	bedside table	50/40/40

				Dimension cm
<b>Prestige 18</b>	Rahmen Breiten Längen	cadre largeurs longueurs	frame widths lengths	90, 100, 120, 140, 160, 180, 200 190, 200, 210, 220
<b>Slid white</b>	Kufen Breiten Höhen	patins largeurs hauteurs	vats widths heights	140, 160, 180, 200 20, 25
<b>Cussina</b>	Kopfteil, Ranch jeans 662 siehe Register 1	tête de lit, Ranch jeans 662 voir registre 1	headboard, Ranch jeans 662 see index 1	140, 160, 180, 200

Alle Holzteile in weiss | toutes les parties en bois en blanc | all wooden parts in white

Weitere Beimöbel siehe Register 2 | autres accessoires voir registre 2 | further accessories see index 2

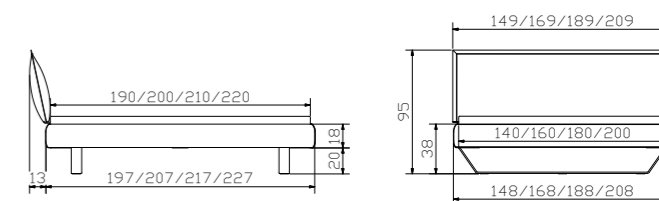



	Dimension cm			
<b>Lovie-Box</b>	1 Bettkasten Breiten 2 Bettkästen Breiten Höhe	1 tiroir de lit largeurs 2 tiroirs de lit largeurs hauteur	1 bed drawer widths 2 bed drawers widths height	90, 100, 120, 140  140, 160, 180, 200 25

	Dimension cm			
<b>Prestige 18</b>	Rahmen Breiten Längen	cadre largeurs longueurs	frame widths lengths	90, 100, 120, 140, 160, 180, 200 190, 200, 210, 220
<b>Tondo anthracit</b>	Füße Höhe	pieds hauteur	feet height	20
<b>Talma</b>	Kopfteil, Shine curry 684 siehe Register 1	tête de lit, Shine curry 684 voir registre 1	headboard, Shine curry 684 see index 1	140, 160, 180, 200
<b>Topa anthracit</b>	Bank inkl. Kissen Shine curry 684	banquette, coussin incl. Shine curry 684	bench, cushion incl. Shine curry 684	144/44/38
<b>Mino</b>	Nachttisch	table de nuit	bedside table	50/40/40

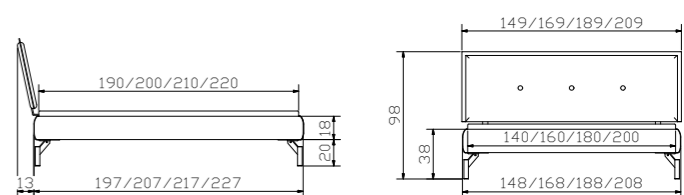
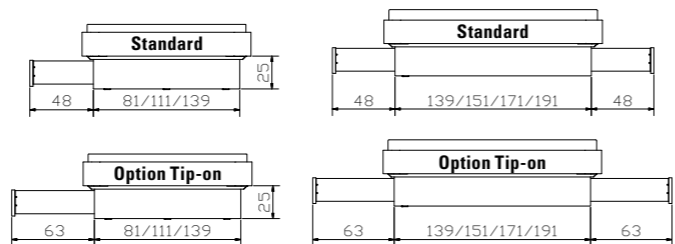

**Alle Holzteile in Anthracit** | toutes les parties en bois en anthracite | all wooden parts in anthracite  
**Weitere Beimöbel siehe Register 2** | autres accessoires voir registre 2 | further accessories see index 2



				Dimension cm
<b>Viola</b>	Kommode	commode	chest of drawers	105/45/74
<b>Triore</b>	Nachttisch	table de nuit	bedside table	50/40/58

				Dimension cm
<b>Prestige 18</b>	Rahmen Breiten Längen	cadre largeurs longueurs	frame widths lengths	90, 100, 120, 140, 160, 180, 200 190, 200, 210, 220
<b>Practico-Box</b>	Breiten Längen Höhe	largeurs longueurs hauteur	widths lengths height	90, 100, 120, 140, 160, 180, 200 200, 210, 220 25
<b>Gabo</b>	Kopfteil, Casual cognac 332 siehe Register 1	tête de lit, Casual cognac 332 voir registre 1	headboard, Casual cognac 332 see index 1	90, 100, 120, 140, 160, 180, 200

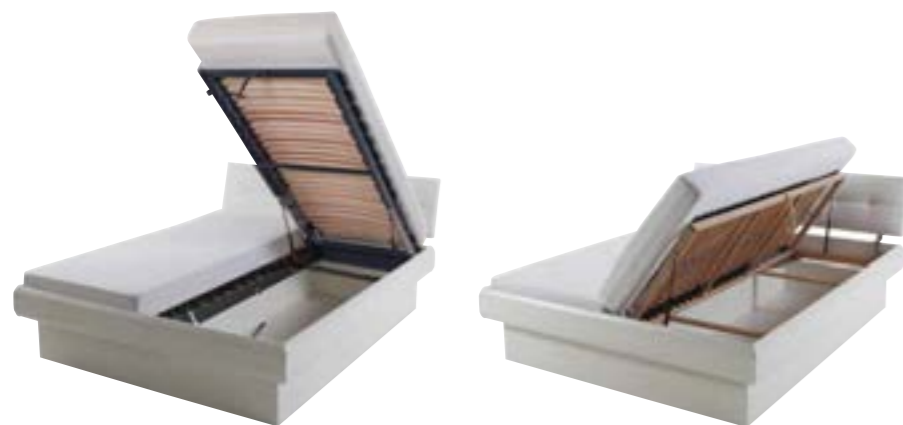

**Details siehe Seite 3.9**  
Détails voir page 3.9  
Details see page 3.9

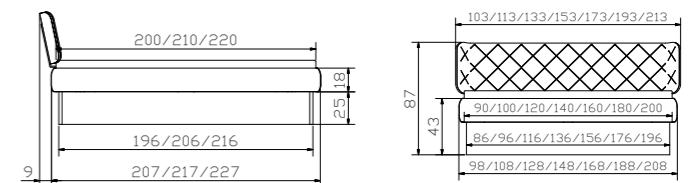

**Alle Holzteile in Walnuss oder Anthracit** | toutes les parties en bois en noyer ou anthracite | all wooden parts in walnut or anthracite



				Dimension cm
<b>Viola</b>	Kommode	commode	chest of drawers	105/45/74
<b>Mino</b>	Nachttisch	table de nuit	bedside table	50/40/40
<b>Smart black</b>	Lampen (2er Set) schwarz 12V DC, 30 LED warm Dreistufenschaltung	lamps (set de 2) noir 12V DC, 30 LED warm Interrupteur à 3 crans	lamps (set of 2) nero 12V DC, 30 LED warm Three step circuit	

				Dimension cm
<b>Prestige 18</b>	Rahmen Breiten Längen	cadre largeurs longueurs	frame widths lengths	90, 100, 120, 140, 160, 180, 200 190, 200, 210, 220
<b>Mico anthracit</b>	Füße Höhen	pieds hauteurs	feet heights	10, 20, 25, 30
<b>Nuetta</b>	Kopfteil	tête de lit	headboard	90/100, 120, 140, 160, 180, 200

**Alle Holzteile in Anthracit oder Eiche sägerauh natur** | toutes les parties en bois en anthracite ou chêne brut de sciage naturel | all wooden parts in anthracite or oak rough sawn natural

**Lampen und weitere Beimöbel siehe Register 2** | lampes et autres accessoires voir registre 2 | lamps and further accessories see index 2

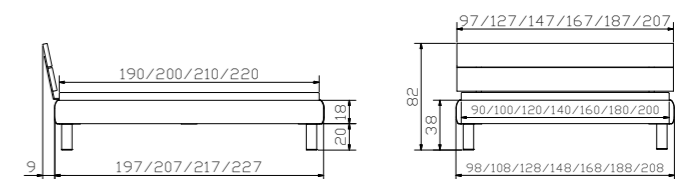



				Dimension cm
<b>Duqa</b> anthracit	Nachttisch	table de nuit	bedside table	48/38/40

				Dimension cm
<b>Prestige 18</b>	Rahmen Breiten Längen	cadre largeurs longueurs	frame widths lengths	90, 100, 120, 140, 160, 180, 200 190, 200, 210, 220
<b>Vilo</b> anthracit	Füße Breiten Höhen	pieds largeurs hauteurs	feet widths heights	90, 100, 120, 140, 160, 180, 200 20
<b>Nuetta</b>	Kopfteil	tête de lit	headboard	90/100, 120, 140, 160, 180, 200

**Alle Holzteile in Beton Nachbildung** | toutes les parties en bois en beton laminé | all wooden parts in concrete laminated

**Duqa = Auflageplatte Echtbeton** | plaque d'appui béton véritable | support plate real concrete

**Weitere Beimöbel siehe Register 2** | autres accessoires voir registre 2 | further accessories see index 2

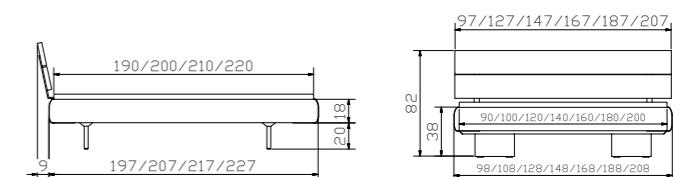



				Dimension cm
<b>Viola</b>	Kommode	commode	chest of drawers	105/45/74
<b>Mino</b>	Nachttisch	table de nuit	bedside table	50/40/40
<b>Emilio alu</b>	Herrendiener	valet	dressboy	45/28/111
<b>Smart white</b>	Lampen (2er Set), weiss 12V DC, 30 LED warm Dreistufenschaltung	lampes (set de 2), blanc 12V DC, 30 LED warm interrupteur à 3 crans	lamps (set of 2), white 12V DC, 30 LED warm three step circuit	

				Dimension cm
<b>Prestige 18</b>	Rahmen Breiten Längen	cadre largeurs longueurs	frame widths lengths	90, 100, 120, 140, 160, 180, 200 190, 200, 210, 220
<b>Masi</b>	Füsse Höhen	pieds hauteurs	feet heights	20, 25
<b>Boga</b>	Kopfteil, Campos blanc 372 siehe Register 1	tête de lit, Campos blanc 372 voir registre 1	headboard, Campos blanc 372 see index 1	90, 100, 120, 140, 160, 180, 200

**Alle Holzteile in weiss oder Esche hell** | toutes les parties en bois en blanc ou frêne clair | all wooden parts in white or ash light  
**Lampen und weitere Beimöbel siehe Register 2** | lampes et autres accessoires voir registre 2 | lamps and further accessories see index 2

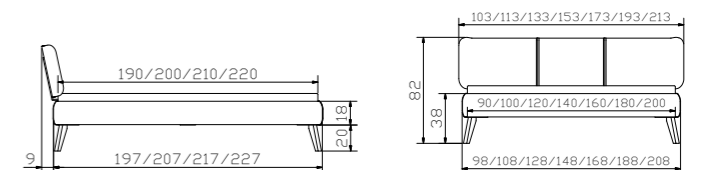



				Dimension cm
<b>Viola</b>	Kommode	commode	chest of drawers	105/45/74
<b>Mino</b>	Nachttisch	table de nuit	bedside table	50/40/40

				Dimension cm
<b>Prestige 18</b>	Rahmen Breiten Längen	cadre largeurs longueurs	frame widths lengths	90, 100, 120, 140, 160, 180, 200 190, 200, 210, 220
<b>Cantu</b>	Füße Höhen	pieds hauteurs	feet heights	20, 25, 30
<b>Umbia L</b>	Wandpaneel Campos blanc 372 nur für Wandmontage siehe Register 1	panneau mural Campos blanc 372 uniquement pour montage mural voir registre 1	wall panel Campos blanc 372 wall assembly only see index 1	153, 173, 193, 213

**Alle Holzteile in Buche oder weiss** | toutes les parties en bois en hêtre ou blanc | all wooden parts in beech or white  
**Weitere Beimöbel siehe Register 2** | autres accessoires voir registre 2 | further accessories see index 2

