



swiss bed concept



**HASENA**  
the dream factory



# BOX Spring *Classic*



## 5 Schritte zum Boxspring-Comfort Bett

5 étapes vers votre lit Boxspring-Comfort | 5 steps to your bed Boxspring-Comfort

### 1. Untergestell | sommier | mattress base

#### Classic-Box 26



**Classic-Box 26 in 41 verschiedenen Stofffarben erhältlich. Holzrahmen aus Tanne oder Fichte massiv und Taschenfederkern mit 7 Zonen, 324 Federn pro Liegefläche (100/200).**

Classic-Box 26 disponible en 41 couleurs de tissu différentes. Cadre en bois de sapin ou d'épicéa massif et noyau de ressorts ensachés avec 7 zones, 324 ressorts par surface de couchage (100/200).

Classic-Box 26 in 41 different fabric colours available. Solid fir or spruce wooden frame and pocket spring core with 7 zones, 324 springs per lying surface (100/200).

### 2. Füße | pieds | feet

#### Masi



**Zu Classic-Box 26 sind nur Füße oder Sockel in 10 cm Höhe möglich.**

Avec Classic-Box 26 seuls les pieds ou socle en hauteur 10 cm sont possibles.

For Classic-Box 26 only feet or socket in height 10 cm are possible.

### 3. Kopfteil | tête de lit | headboard

#### Florenz



**Grosse Auswahl an Kopfteilen und Wandpaneelen, siehe Seiten 4.6–4.11, in verschiedenen Stoffen, siehe Seite 1.15.**

Grand choix de têtes de lit et panneaux muraux, voir pages 4.6–4.11, dans différents tissus, voir page 1.15.

Large selection of headboards and wallpanels, see page 4.6–4.11, in different fabrics, see page 1.15.

### 4. Ihre Wunschmatratze | votre matelas préféré | your preferred mattress



**Wählen Sie Ihre Matratze aus verschiedenen Varianten und Härtegraden, siehe Register 10 (Matratzen).**

Choisissez votre matelas dans différentes variantes et différents degrés de fermeté, voir registre 10 (matelas).

Choose your mattress in different variations and degrees of hardness, see index 10 (mattresses).

### 5. Ihr Wunschtopper | votre surmatelas préféré | your preferred mattress topper



**Wählen Sie zwischen 6 Möglichkeiten für Ihren persönlichen Komfort, siehe Register 11 (Topper).**

Choisissez entre 6 possibilités pour votre confort personnel, voir registre 11 (surmatelas).

Choose between 6 possibilities for your personal comfort, see index 11 (topper).

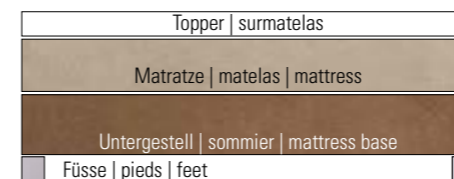

**Bis zur Breite 140 cm bieten wir das Untergestell 1-sektorig an.**

Jusqu'à la largeur 140 cm nous proposons le sommier en 1 pièce.

Until the width of 140 cm we offer the mattress base in one piece.



**Ab Breite 140 cm bieten wir das Untergestell 2-sektorig an. Sie entscheiden je nach Schlafgewohnheiten, ob 1 oder 2 Matratzen und 1 oder 2 Topper für Sie ideal sind.**

A partir de la largeur 140 cm nous proposons le sommier en 2 pièces. Vous décidez en fonction de vos habitudes de sommeil si 1 ou 2 matelas et si 1 ou 2 surmatelas vous convient le mieux.

From width 140 cm we offer the mattress base in 2 pieces.

You decide, depending on your sleeping habits whether 1 or 2 mattresses and whether 1 or 2 toppers are ideal for you.



## Classic-Box 26

**Breiten** | largeurs | widths  
90, 100, 120, 140, 160, 180, 200 cm

**Längen** | longueurs | lengths  
200, 210, 220 cm

**Höhe** | hauteur | height  
26 cm

## Classic-Move 26

**Breiten** | largeurs | widths  
90, 100, 160, 180, 200 cm

**Längen** | longueurs | lengths  
200, 210, 220 cm

**Höhe** | hauteur | height  
26 cm

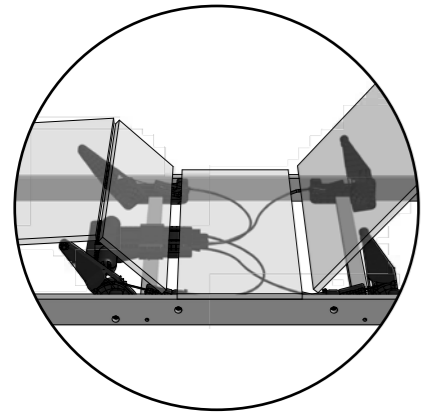

Bei den Boxspring-Motorbetten «Move 26» wird die Technik OCTObox eingebaut. Dieses weltweit einzigartige und patentierte Antriebskonzept reduziert das Gewicht und überzeugt durch seine enorme Systemkraft, angetrieben durch 2 flüsterleise Motoren. Zudem bietet das Konzept eine stufenlose Verstellung der Liegefläche in fast jede gewünschte Position. Es werden modernste Werkstoffe verwendet, um ein Höchstmass an Stabilität und Funktionalität zu gewährleisten.

## Motor | moteur | motor

- Spannung nur 24 V
- gefertigt nach VDE, Schutzart IP20
- sehr geringer Standby-Verbrauch nach EU Ökodesign-Richtlinie
- Notabsenkung mechanisch

- Funkfernbedienung mit Soft-touch, inkl. LED-Hintergrundbeleuchtung
- mit Haltetasche für Fernbedienung in passender Farbe der Box

- stoffbezogener Matratzenbügel, verhindert das Rutschen nach vorne

Zur Befestigung aller Kopfteile an Classic-Move 26 benötigen Sie zwingend ein Verbindungsbrett «Board-Move», siehe Seite 4.6.

Aufgrund der elastischen, flexiblen Struktur und dadurch hohen Anpassungsfähigkeit eines Kaltschaumkerns, empfehlen wir für Boxspring-Motorbetten «Move 26» unsere Matratze VICTORIA (Register 10, Seiten 10.10–10.11.).

Stoffauswahl siehe Seite 1.15 | choix de tissus voir page 1.15 | choice of fabrics see page 1.15

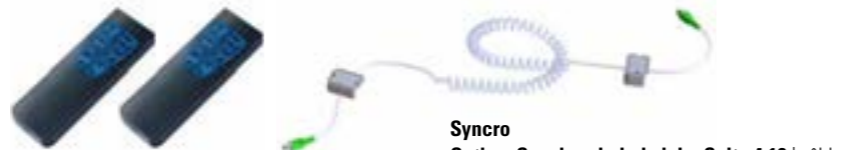

**Syncro**  
Option: Synchronkabel siehe Seite 4.16 | câble de synchronisation voir page 4.16 | synchronization cable see page 4.16

La technique OCTObox est désormais intégrée aux lits à moteur Boxspring « Move 26 ». Ce concept d'entraînement breveté et unique au monde, réduit le poids et convainc par l'énorme puissance de son système, entraîné par 2 moteurs silencieux. Le concept offre en outre un réglage en continu de la surface de couchage dans presque chaque position souhaitée. Des matériaux ultramodernes sont utilisés pour garantir un maximum de stabilité et de fonctionnalité.

- voltage seulement 24 V
- fabriqué selon VDE, type de protection IP20
- consommation très faible en mode standby selon directive sur l'écoconception EU
- abaissement de secours mécanique

- télécommande sans fil avec Soft-touch, rétro-éclairage LED inclus
- avec pochette pour télécommande assortie au coloris de la box

- support de matelas recouvert de tissu empêche le glissement vers l'avant

Pour la fixation de toutes les têtes de lit à Classic-Move 26 une planche de raccordement « Board-Move » est indispensable, voir page 4.6.

Du fait de sa structure élastique et flexible, et par conséquent grande faculté d'adaptation du noyau en mousse froide, nous conseillons notre matelas VICTORIA pour les lits à moteur Boxspring « Move 26 » (registre 10, pages 10.10–10.11.).

The Boxspring motor beds «Move 26» are fitted with OCTObox technology. This patented drive concept, which is unique in the world, reduces the weight and appeals for its tremendous system strength that is powered by 2 whisper-quiet motors. The concept also offers continuous adjustment of the lying surface into almost any desired position. Uses the latest materials in order to guarantee maximum stability and functionality.

- voltage 24 V only
- manufactured VDE, protection category IP20
- very low standby-consumption according to the EU Ecodesign Directive
- emergency-lowering mechanically

- radio remote control with soft-touch, LED background lighting inclusive
- with pocket for remote-control in matching colour of the box

- fabric-covered mattress holder, prevents sliding to the front

For fixation of all headboards to Classic-Move 26 a connection board «Board-Move» is absolutely necessary, see page 4.6.

Because of the elastic, flexible structure and thereby high adaptability of a cold foam core, we recommend our mattress VICTORIA for Boxspring motor beds «Move 26» (index 10, pages 10.10–10.11.).

# Füsse | pieds | feet

## Holz | bois | wood

Ivio



Masi



Otino



## Metall | métal | metal

Caro



Jeno



Mico



Reca



Stomp



	Masse cm dim. cm	Höhen cm hauteurs cm heights cm	Farben couleurs colours
<b>Holz</b>   bois   wood		10	10 62 64 73 80 85 90 93 96 98
Ivio	10 x 10	●	● ● ● ● ● ● ● ● ● ●
Masi	3,5	●	● ● ● ● ● ● ● ● ● ●
Otino	18,5 x 18,5	●	● ● ● ● ● ● ● ● ● ●
<b>Metall</b>   métal   metal		10	00 04 16 42 43 45
Caro	6x6	●	● ● ● ● ● ● ● ● ● ●
Jeno	12x5	●	● ● ● ● ● ● ● ● ● ●
Mico	8x8	●	● ● ● ● ● ● ● ● ● ●
Reca	24x12	●	● ● ● ● ● ● ● ● ● ●
Stomp	∅8	●	● ● ● ● ● ● ● ● ● ●

## Ausführungen | exécutions | executions

### Holz | bois | wood

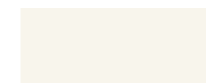

**10**  
**Buche weiss, deckend lackiert**  
Hêtre blanc couvrant, laqué  
Beech white covered, lacquered



**62**  
**Akazie Vintage brown, lackiert**  
Acacia Vintage brown, laqué  
Acacia Vintage brown, lacquered



**64**  
**Akazie Vintage grey, lackiert**  
Acacia Vintage grey, laqué  
Acacia Vintage grey, lacquered



**73**  
**Eiche bianco, gebürstet, geölt**  
Chêne bianco, brossé, huilé  
Oak bianco, brushed, oiled



**80**  
**Kernbuche natur, geölt**  
Hêtre cœur rouge naturel, huilé  
Heart beech natural, oiled



**85**  
**Nussbaum geölt**  
Noyer huilé  
Walnut oiled



**90**  
**Wildeiche Vintage natur, geölt**  
Chêne nouveau Vintage naturel, huilé  
Wildoak Vintage natural, oiled



**93**  
**Wildeiche natur, gebürstet, geölt**  
Chêne nouveau naturel, brossé, huilé  
Wildoak natural, brushed, oiled



**96**  
**Wildeiche pure, gebürstet, geölt**  
Chêne nouveau pure, brossé, huilé  
Wildoak pure, brushed, oiled



**98**  
**Wildeiche coffee, gebürstet, geölt**  
Chêne nouveau coffee, brossé, huilé  
Wildoak coffee, brushed, oiled

### Metall | métal | metal



**00**  
**Chrom**



**04**  
**Used**



**16**  
**Anthracit**



**42**  
**Alu**



**43**  
**Inox**



**45**  
**Iron**

**Chrom** = Metall verchromt | métal chromé | metal chrome-plated

**Used** = Metall galvanisiert | métal galvanisé | metal galvanised

**Anthracit** = Metall pulverbeschichtet | métal thermolaqué | metal powder-coated

**Alu** = Metall pulverbeschichtet | métal thermolaqué | metal powder-coated

**Inox** = Edelstahl gebürstet | acier inoxydable brossé | stainless steel brushed

**Iron** = Metall geflammt, pulverbeschichtet | métal flammé, thermolaqué | metal mottled, powder-coated

# Kopfteile | têtes de lit | headboards

Holz, gepolstert | bois, rembourrées | wood, upholstered



## Ausführungen | exécutions | executions

Holz | bois | wood



**62 Akazie Vintage brown, lackiert**  
Acacia Vintage brown, laqué  
Acacia Vintage brown, lacquered



**64 Akazie Vintage grey, lackiert**  
Acacia Vintage grey, laqué  
Acacia Vintage grey, lacquered

**Massangabe der Kopfteilhöhe ist ab Boden** | la hauteur de la tête de lit est mesurée à partir du sol | dimension of the headboard is the height from the floor

## 3 Komponenten für eine flexible Liegefläche

3 composants pour un couchage flexible | 3 components for a flexible lying surface

### Classic-Move 26

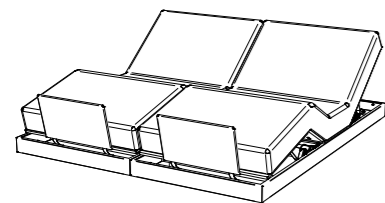

Untergestell | sommier | mattress base

### Board-Move

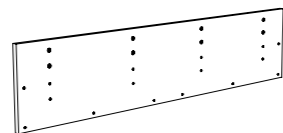

Verbindungs Brett | planche de raccordement | connection boardbase

### Torino

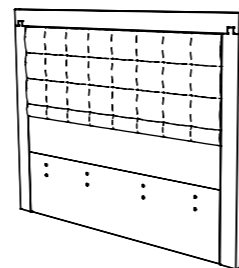

Kopfteil | tête de lit | headboard

### Board-Move



**Zur Befestigung aller Kopfteile an Classic-Move 26 benötigen Sie zwingend das Verbindungs Brett «Board-Move».**

Pour la fixation de toutes les têtes de lit au Classic-Move 26 la planche de raccordement « Board-Move » est indispensable.

For fixation of all headboards to Classic-Move 26 the connection board «Board-Move» is absolutely necessary.

# Kopfteile | têtes de lit | headboards

Holz, gepolstert | bois, rembourrées | wood, upholstered

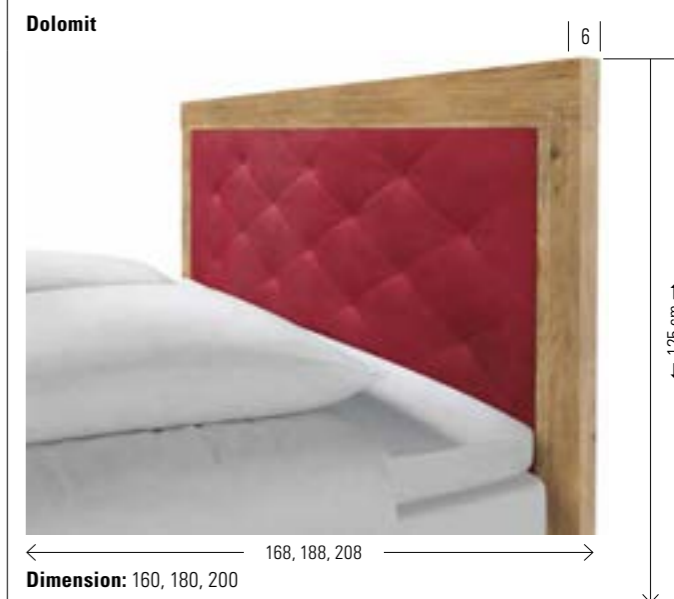

**Massangabe der Kopfteilhöhe ist ab Boden** | la hauteur de la tête de lit est mesurée à partir du sol | dimension of the headboard is the height from the floor

Stoffauswahl siehe Seite 1.15 | choix de tissus voir page 1.15 | choice of fabrics see page 1.15

## Ausführungen | exécutions | executions

Holz | bois | wood



**90 Wildeiche Vintage natur, geölt**  
Chêne nouveaux Vintage naturel, huilé  
Wildoak Vintage natural, oiled



**93 Wildeiche natur, gebürstet, geölt**  
Chêne nouveaux naturel, brossé, huilé  
Wildoak natural, brushed, oiled



**96 Wildeiche pure, gebürstet, geölt**  
Chêne nouveaux pure, brossé, huilé  
Wildoak pure, brushed, oiled



**98 Wildeiche coffee, gebürstet, geölt**  
Chêne nouveaux coffee, brossé, huilé  
Wildoak coffee, brushed, oiled

# Kopfteile | têtes de lit | headboards

Holz, gepolstert | bois, rembourrées | wood, upholstered



Massangabe der Kopfteilhöhe ist ab Boden | la hauteur de la tête de lit est mesurée à partir du sol | dimension of the headboard is the height from the floor  
 Stoffauswahl siehe Seite 1.15 | choix de tissus voir page 1.15 | choice of fabrics see page 1.15

## Ausführungen | exécutions | executions

Holz | bois | wood



**73**  
**Eiche bianco,**  
**gebürstet, geölt**  
 Chêne bianco, brossé,  
 huilé  
 Oak bianco, brushed,  
 oiled

# Kopfteile | têtes de lit | headboards

gepolstert | rembourrées | upholstered

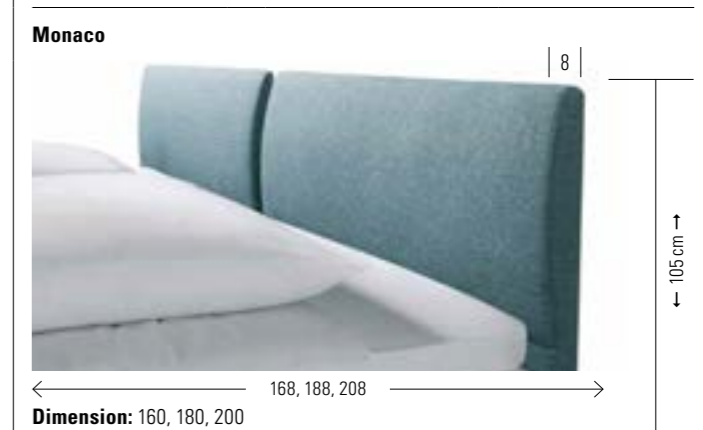
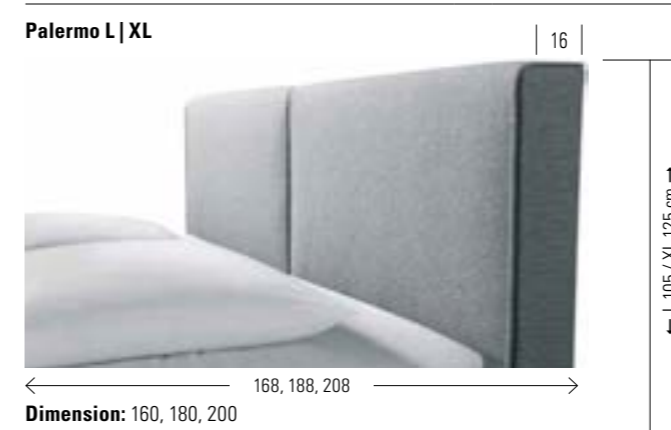
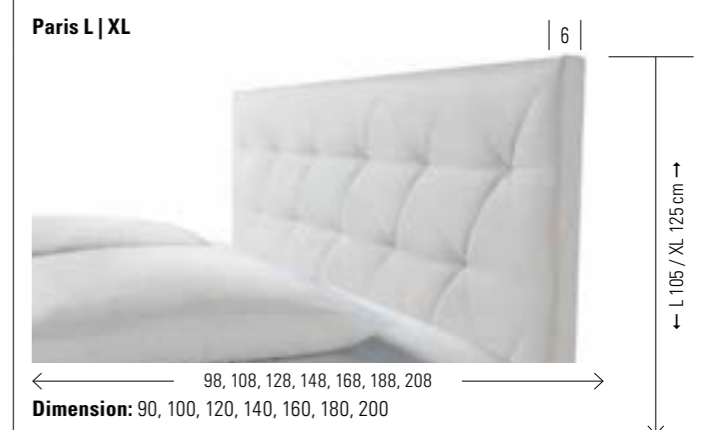
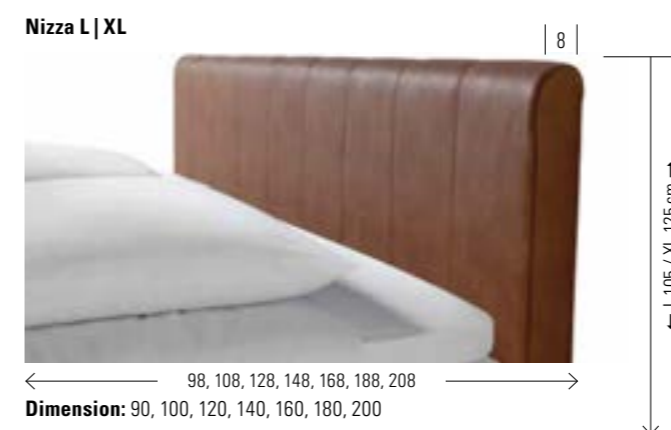
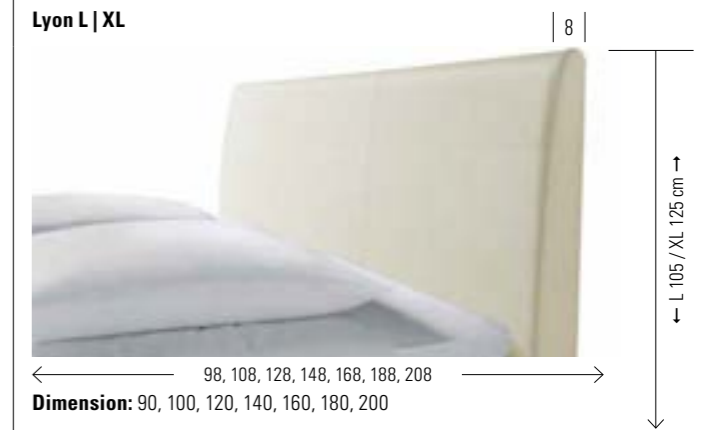
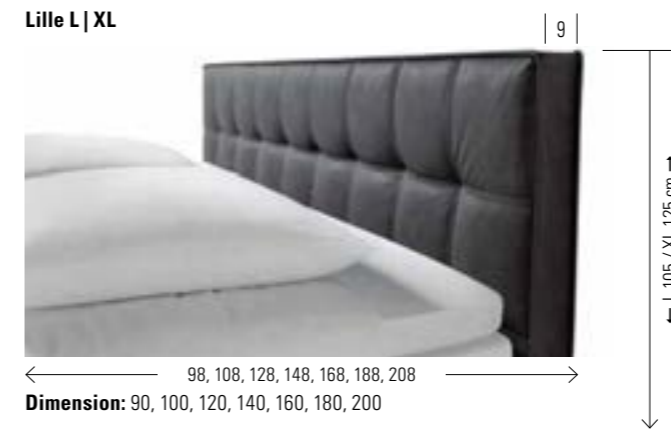

Stoffauswahl siehe Seite 1.15 | choix de tissus voir page 1.15 | choice of fabrics see page 1.15

# Kopfteile | têtes de lit | headboards

gepolstert | rembourrées | upholstered

**Azina**

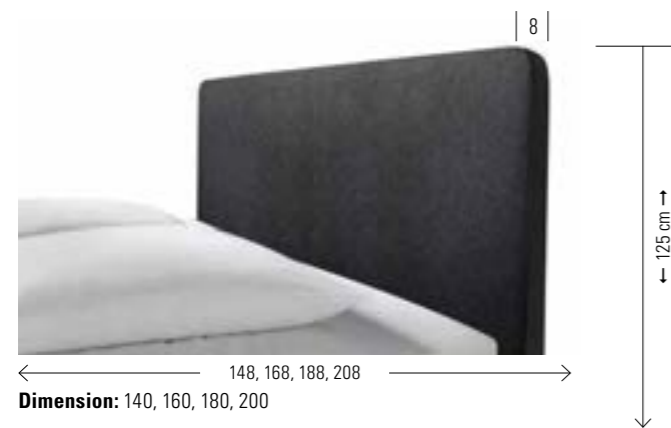

Dimension: 140, 160, 180, 200

**Florenz**

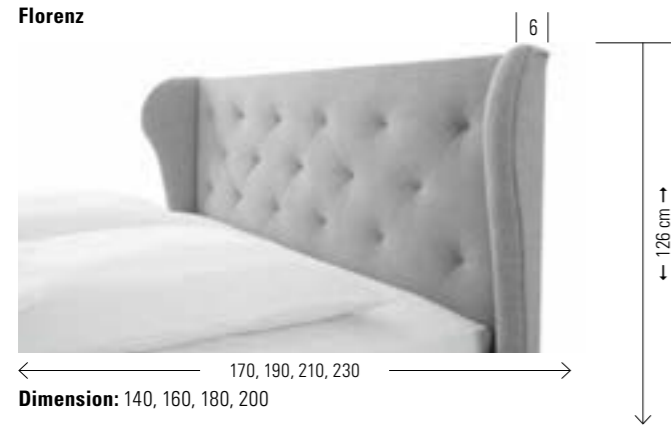

Dimension: 140, 160, 180, 200

**Combino**



**Lucina** mit integrierten Lampen | avec lampes intégrées | with integrated lamps

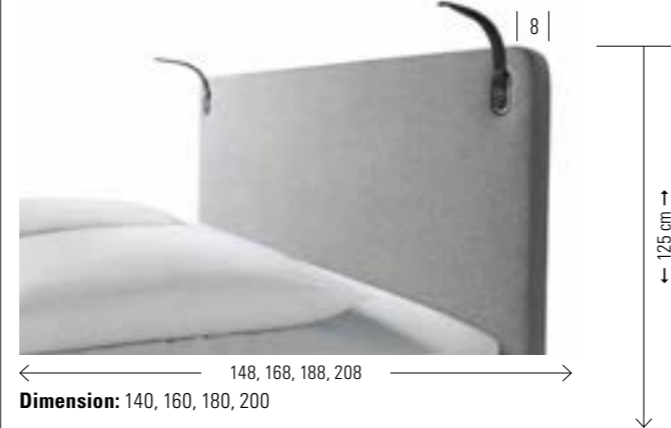

Dimension: 140, 160, 180, 200

**Stoffauswahl siehe Seite 1.15**  
Choix de tissus voir page 1.15  
Choice of fabrics see page 1.15

**Bei Kopfteilen Lyon und Florenz sind die Lampen nicht montierbar**  
Les lampes ne peuvent pas être montées sur les têtes de lit Lyon et Florence  
Lamps cannot be fitted to the headboards Lyon and Florence

**Lampenadapter für die Lampen** | adaptateur pour les lampes | adapter for the lamps  
**Boa, Smart, Snake, Tina**

**Adapter zur Befestigung der Lampen (Register 1, Seiten 1.2–1.3) an folgenden Kopfteilen** | adaptateur pour la fixation des lampes (registre 1, pages 1.2–1.3) aux têtes de lits suivantes | adapter to assemble the lamps (index 1, pages 1.2–1.3) to the following headboards

**Lille, Nizza, Palermo, Milano, Azina - Seite/page 4.9–4.10**

## Information zu Kopfteil Lucina | informations sur la tête de lit Lucina | information about headboard Lucina

**Lampe mit flexiblem Hals, USB-Anschluss und separatem Orientierungslicht für die Nacht, nur in Kombination mit Kopfteil Lucina erhältlich** | lampe à cou flexible, port USB et lumière à orientation séparée pour la nuit, uniquement disponible en combinaison avec la tête de lit Lucina | lamp with flexible neck, USB connection and separate orientation light for the night, only available in combination with headboard Lucina



**Lampen (2er Set) schwarz**  
12V DC, LED neutral, 80 lm

lamps (set of 2) noir  
12V DC, LED neutre, 80 lm

lamps (set of 2) black  
12V DC, LED neutral, 80 lm

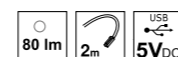

**Weitere Lampen und Informationen siehe Register 1, Seiten 1.2–1.3** | davantage de lampes et informations plus détaillées voir registre 1, pages 1.2–1.3  
other lamps and detailed information see index 1, pages 1.2–1.3

# Wandpaneele | panneaux muraux | wallpanels

**Colina L | XL**

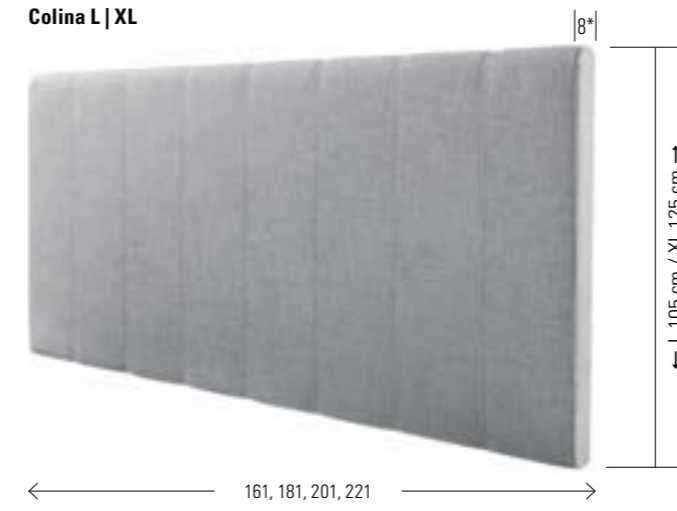

161, 181, 201, 221

**Saia M | L**

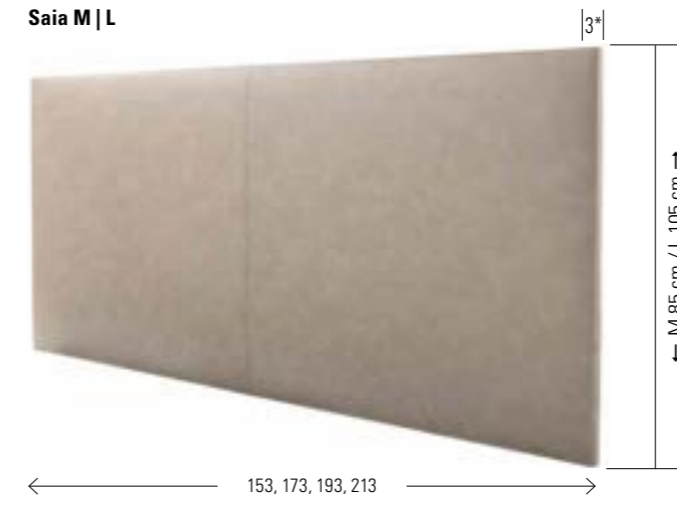

153, 173, 193, 213

**Umbia L**

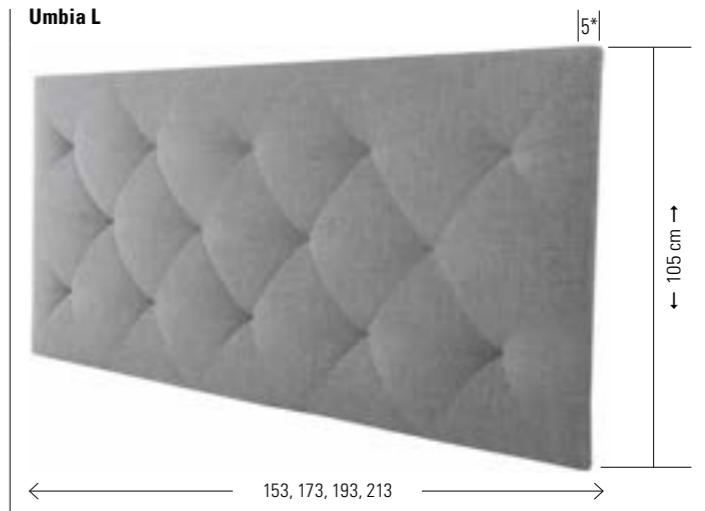

153, 173, 193, 213

**Sogno L | XL**



161, 181, 201, 221

**\*Zusätzlich zum angegebenen Mass: Der Abstand zwischen Paneel und Wand beträgt 3 cm.** | En plus de la dimension indiquée: La distance entre le panneau et le mur est de 3 cm. | Additional to the indicated dimension: The distance between panel and wall is 3 cm.

**Stoffauswahl siehe Seite 1.15** | choix de tissus voir page 1.15 | choice of fabrics see page 1.15

**Combino**



**Lampenadapter für die Lampen** | adaptateur pour les lampes | adapter for the lamps  
**Boa, Smart, Snake, Tina**

**Adapter zur Befestigung der Lampen (Register 1, Seiten 1.2–1.3) an folgenden Wandpaneelen** | adaptateur pour la fixation des lampes (registre 1, pages 1.2–1.3) aux panneaux muraux suivants | adapter to assemble the lamps (index 1, pages 1.2–1.3) to the following wallpanels

**Colina**

## Lampen, 2er Set | lampes, set de 2 | lamps, set of 2

**Boa chrom**



12V DC, 12 LED, 60 lm

**Smart black**



12V DC, 30 LED, 183 lm

**Smart white**



12V DC, 30 LED, 183 lm

**Weitere Lampen und Informationen siehe Register 1, Seiten 1.2–1.3** | davantage de lampes et informations plus détaillées voir registre 1, pages 1.2–1.3  
other lamps and detailed information see index 1, pages 1.2–1.3





				Dimension cm
<b>Circo 52</b>	Nachttisch/Hocker	table de nuit/tabouret	bedside table/stool	Ø 45/52
<b>Silvio inox</b>	Herrendiener	valet	dressboy	45/28/103

				Dimension cm
<b>Classic-Box 26</b>	Untergestell Breiten Längen	sommier largeurs longueurs	mattress base widths lengths	140, 160, 180, 200 200, 210, 220
<b>Mico anthracit</b>	Füße Höhe	pieds hauteur	feet height	10
<b>Lucina</b>	Kopfteil mit integrierten Lampen Lampen (2er Set) schwarz 12V DC, LED neutral	tête de lit avec lampes intégrées lampes (set de 2) noir 12V DC, LED neutre	headboard with integrated lamps lamps (set of 2) black 12V DC, LED neutral	140, 160, 180, 200
<b>Tex Topper</b>	Matratze Topper Breiten Längen	matelas surmatelas largeurs longueurs	mattress mattress topper widths lengths	80, 90, 100, 140, 160, 180, 200 200, 210, 220



**Lucina**  
**Kopfteil mit integrierten Lampen** | tête de lit avec lampes intégrées | headboard with integrated lamps

**Lampe mit flexiblem Hals, USB-Anschluss und separatem Orientierungslicht für die Nacht, nur in Kombination mit Kopfteil Lucina erhältlich** | lampe à cou flexible, port USB et lumière à orientation séparée pour la nuit, uniquement disponible en combinaison avec la tête de lit Lucina | lamp with flexible neck, USB connection and separate orientation light for the night, only available in combination with headboard Lucina

**Weitere Lampen siehe Register 1** | davantage de lampes voir registre 1 | other lamps see index 1

**Alle Polsterteile in Kitana anthrazit 604** | toutes les parties rembourrées en Kitana anthrazit 604 | all upholstery parts in Kitana anthrazit 604

**Alle Holzteile in Nussbaum, geölt** | toutes les parties en bois en noyer, huilé | all wooden parts in walnut, oiled

**Weitere Beimöbel siehe Register 1** | davantage d'accessoires voir registre 1 | other accessories see index 1

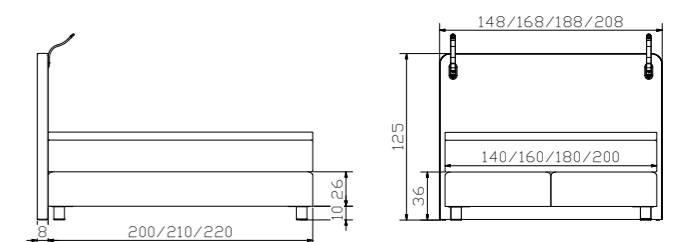



				Dimension cm
<b>Covaro</b>	Kommode	commode	chest of drawers	120/49/90
<b>Covo</b> inox	Griffe (4er Set)	poignées (set de 4)	handles (set of 4)	
<b>Seda</b>	Bank	banquette	bench	120/35/38
<b>Banc</b>	Kissen	coussin	cushion	119/34/6
<b>Treva</b>	Nachttisch	table de nuit	bedside table	48/40/51
<b>Silvio</b> inox	Herrendiener	valet	dressboy	45/28/103

#### Syncro



#### Option:

Das Synchronkabel «Syncro» dient zum Synchronisieren von zwei nebeneinanderliegenden Motorrahmen.

#### Vorteile des Synchronkabels:

- Verwendung beider Funkfernbedienungen
- gleichmäßiges Verfahren der Antriebssysteme trotz unterschiedlicher Belastung
- Verwendung einer durchgehenden Matratze möglich

Le câble de synchronisation « Syncro » est utilisé pour synchroniser deux châssis moteurs adjacents.

Avantages du câble de synchronisation :

- utilisation des deux télécommandes radio
- un mouvement uniforme des systèmes d'entraînement malgré des charges différentes
- possibilité d'utiliser un matelas continu

The synchronization cable «Syncro» is used to synchronise two adjacent motorised frames.

Advantages of the synchronization cable:

- use of both radio remote controls
- uniform movement of the drive systems despite different loads
- use of an one-piece double-sized mattress possible

				Dimension cm
<b>Classic-Move 26</b>	Untergestell Breiten Längen	sommier largeurs longueurs	mattress base widths lengths	90, 100, 160, 180, 200 200, 210, 220
<b>Reca</b> inox	Füße Höhe	pieds hauteur	feet height	10
<b>Nizza XL</b>	Kopfteil	tête de lit	headboard	90, 100, 160, 180, 200
<b>Drell Topper</b>	Matratze Topper Breiten Längen	matelas surmatelas largeurs longueurs	mattress mattress topper widths lengths	80, 90, 100, 160, 180, 200 200, 210, 220

**Alle Polsterteile in Alpina lightgrey 390** | toutes les parties rembourrées en Alpina lightgrey 390 | all upholstery parts in Alpina lightgrey 390

**Alle Holzteile in Buche schoko, lackiert** | toutes les parties en bois en hêtre teinté chocolat, laqué | all wooden parts in beech chocolate coloured, lacquered

**Weitere Beimöbel siehe Register 1** | davantage d'accessoires voir registre 1 | other accessories see index 1

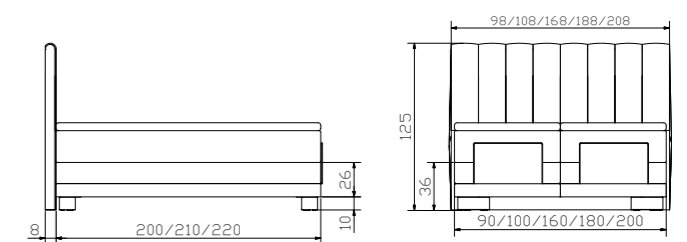



				Dimension cm
<b>Topa</b> bronze	Bank, inklusive Kissen	banquette, coussin inclus	bench, cushion included	144/44/38
<b>Lina</b> bronze	Nachttisch	table de nuit	bedside table	∅ 45/52



**NEU: Matratze Majestic siehe Register 10, Seiten 10.12–10.13 |**  
 NOUVEAU : matelas Majestic voir registre 10, pages 10.12–10.13 |  
 NEW: Mattress Majestic see index 10, pages 10.12–10.13

				Dimension cm
<b>Classic-Box 26</b>	Untergestell Breiten Längen	sommier largeurs longueurs	mattress base widths lengths	90, 100, 120, 140, 160, 180, 200 200, 210, 220
<b>Ivio</b>	Füsse Höhe	pieds hauteur	feet height	10
<b>Lyon XL</b>	Kopfteil	tête de lit	headboard	90, 100, 120, 140, 160, 180, 200
<b>Drell Topper</b>	Matratze Topper Breiten Längen	matelas surmatelas largeurs longueurs	mattress mattress topper widths lengths	80, 90, 100, 140, 160, 180, 200 200, 210, 220

**Alle Polsterteile in Shine musk 683** | toutes les parties rembourrées en Shine musk 683 | all upholstery parts in Shine musk 683

**Alle Holzteile in Nussbaum, geölt** | toutes les parties en bois en noyer, huilé | all wooden parts in walnut, oiled

**Weitere Beimöbel siehe Register 1** | davantage d'accessoires voir registre 1 | other accessories see index 1

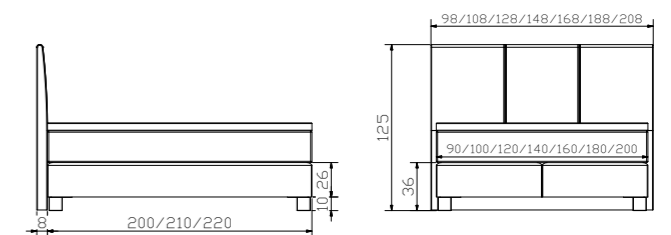



				Dimension cm
<b>Sola</b>	Bank	banquette	bench	140/37/38
<b>Topia</b>	Kissen	coussin	cushion	140/37/10
<b>Noma</b>	Nachttisch	table de nuit	bedside table	48/43/57
<b>Sima 20</b>	Füsse	pieds	feet	

				Dimension cm
<b>Classic-Box 26</b>	Untergestell	sommier	mattress base	
	Breiten	largeurs	widths	140, 160, 180, 200
	Längen	longueurs	lengths	200, 210, 220
<b>Masi</b>	Füsse	pieds	feet	
	Höhe	hauteur	height	10
<b>Florenz</b>	Kopfteil	tête de lit	headboard	140, 160, 180, 200
<b>Drell</b>	Matratze	matelas	mattress	
<b>Topper</b>	Topper	surmatelas	mattress topper	
	Breiten	largeurs	widths	80, 90, 100, 140, 160, 180, 200
	Längen	longueurs	lengths	200, 210, 220

**Alle Polsterteile in Alpina lightgrey 390** | toutes les parties rembourrées en Alpina lightgrey 390 | all upholstery parts in Alpina lightgrey 390  
**Alle Holzteile in Eiche bianco, gebürstet, geölt** | toutes les parties en bois en chêne bianco, brossé, huilé | all wooden parts in oak bianco, brushed, oiled  
**Weitere Beimöbel siehe Register 1** | davantage d'accessoires voir registre 1 | other accessories see index 1

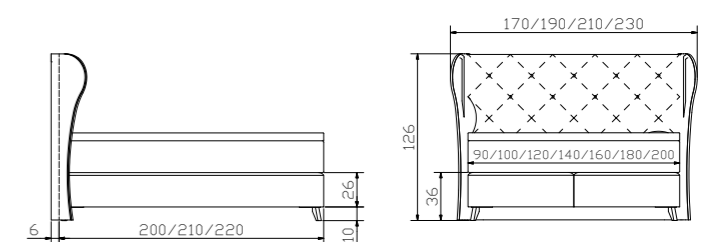



				Dimension cm
<b>Emilio chrom</b>	Herrendiener	valet	dressboy	45/28/111
<b>Trino</b>	Nachttisch	table de nuit	bedside table	50/44/57

				Dimension cm
<b>Classic-Box 26</b>	Untergestell Breiten Längen	sommier largeurs longueurs	mattress base widths lengths	140, 160, 180, 200 200, 210, 220
<b>Stomp chrom</b>	Füsse Höhe	pieds hauteur	feet height	10
<b>Florenz</b>	Kopfteil	tête de lit	headboard	140, 160, 180, 200
<b>Drell Topper</b>	Matratze Topper Breiten Längen	matelas surmatelas largeurs longueurs	mattress mattress topper widths lengths	80, 90, 100, 140, 160, 180, 200 200, 210, 220

**Alle Polsterteile in Campos blanc 372** | toutes les parties rembourrées en Campos blanc 372 | all upholstery parts in Campos blanc 372

**Alle Holzteile in Buche weiss deckend, lackiert** | toutes les parties en bois en hêtre blanc couvrant, laqué | all wooden parts in beech white covered, lacquered

**Weitere Beimöbel siehe Register 1** | davantage d'accessoires voir registre 1 | other accessories see index 1

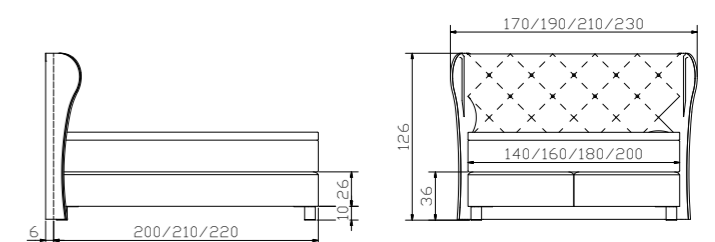



				Dimension cm
<b>Chest</b>	Kommode Korpus MDF betonfarbig lackiert	commode corps en mdf teinté beton, laqué	chest of drawers corpus in mdf concrete coloured, lacquered	105/49/76
<b>Pira</b>	Nachttisch höhenverstellbar Auflageplatte Echtbeton	table de nuit réglable en hauteur plaque d'appui béton véritable	bedside table adjustable in height support plate real concrete	48/38/34–53

				Dimension cm
<b>Classic-Box 26</b>	Untergestell Breiten Längen	sommier largeurs longueurs	mattress base widths lengths	140, 160, 180, 200 200, 210, 220
<b>Jeno used</b>	Füße Höhe	pieds hauteur	feet height	10
<b>Milano M</b>	Kopfteil	tête de lit	headboard	140, 160, 180, 200
<b>Drell Topper</b>	Matratze Topper Breiten Längen	matelas surmatelas largeurs longueurs	mattress mattress topper widths lengths	80, 90, 100, 140, 160, 180, 200 200, 210, 220

**Alle Polsterteile in Alpina navy 393** | toutes les parties rembourrées en Alpina navy 393 | all upholstery parts in Alpina navy 393

**Alle Holzteile in Wildeiche natur, gebürstet, geölt** | toutes les parties en bois en chêne nouveau naturel, brossé, huilé | all wooden parts in wildoak natural, brushed, oiled

**Weitere Beimöbel siehe Register 1** | davantage d'accessoires voir registre 1 | other accessories see index 1

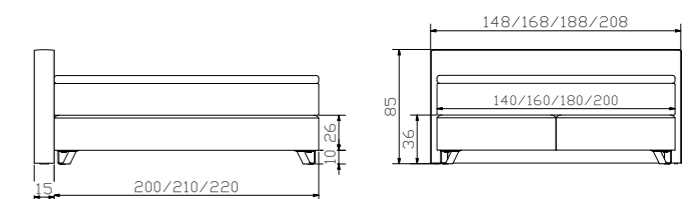



				Dimension cm
<b>Sigma</b>	Kommode	commode	chest of drawers	120/49/76
<b>Sima 10</b>	Füsse	pieds	feet	
<b>Sola</b>	Bank	banquette	bench	140/37/38
<b>Vano</b>	Kissen	coussin	cushion	136/34/3
<b>Noma</b>	Nachttisch	table de nuit	bedside table	48/43/57
<b>Sima 20</b>	Füsse	pieds	feet	

				Dimension cm
<b>Classic-Box 26</b>	Untergestell	sommier	mattress base	
	Breiten	largeurs	widths	160, 180, 200
	Längen	longueurs	lengths	200, 210, 220
<b>Masi</b>	Füsse	pieds	feet	
	Höhe	hauteur	height	10
<b>Izano XL</b>	Kopfteil	tête de lit	headboard	160, 180, 200
<b>Tex Topper</b>	Matratze	matelas	mattress	
	Topper	surmatelas	mattress topper	
	Breiten	largeurs	widths	80, 90, 100, 160, 180, 200
	Längen	longueurs	lengths	200, 210, 220

**Alle Polsterteile in Campos blanc 372** | toutes les parties rembourrées en Campos blanc 372 | all upholstery parts in Campos blanc 372

**Alle Holzteile in Nussbaum geölt** | toutes les parties en bois en noyer huilé | all wooden parts in walnut oiled

**Weitere Beimöbel siehe Register 1** | davantage d'accessoires voir registre 1 | other accessories see index 1

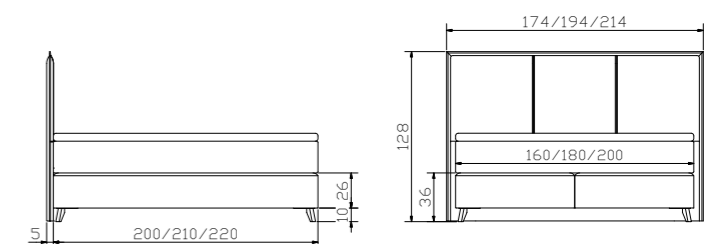



				Dimension cm
<b>Lovara</b>	Kommode	commode	chest of drawers	90/40/75
<b>Treva</b>	Nachttisch	table de nuit	bedside table	48/40/51

				Dimension cm
<b>Classic-Box 26</b>	Untergestell Breiten Längen	sommier largeurs longueurs	mattress base widths lengths	160, 180, 200 200, 210, 220
<b>Ivio</b>	Füsse Höhe	pieds hauteur	feet height	10
<b>Monaco</b>	Kopfteil	tête de lit	headboard	160, 180, 200
<b>Tex Topper</b>	Matratze Topper Breiten Längen	matelas surmatelas largeurs longueurs	mattress mattress topper widths lengths	80, 90, 100, 160, 180, 200 200, 210, 220

**Alle Polsterteile in Kabo calc 630** | toutes les parties rembourrées en Kabo calc 630 | all upholstery parts in Kabo calc 630  
**Alle Holzteile in Kernbuche natur, geölt** | toutes les parties en bois en hêtre coeur rouge naturel, huilé | all wooden parts in heart beech natural, oiled  
**Weitere Beimöbel siehe Register 1** | davantage d'accessoires voir registre 1 | other accessories see index 1

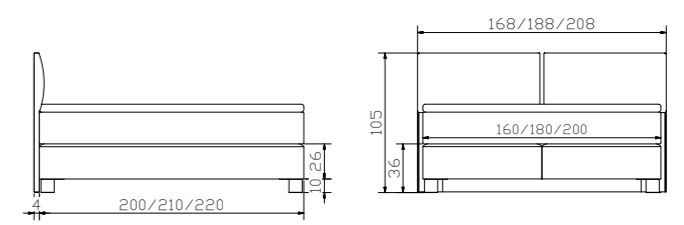



**Dimension cm**

<b>Cessa</b>	Kommode	commode	chest of drawers	120/48/80
<b>Resto Vano</b>	Bank Kissen	banquette coussin	bench cushion	148/37/38 136/34/3
<b>Ludo</b>	Nachttisch	table de nuit	bedside table	40/40/55

**Dimension cm**

<b>Classic-Box 26</b>	Untergestell Breiten Längen	sommier largeurs longueurs	mattress base widths lengths	160, 180, 200 200, 210, 220
<b>Otino iron</b>	Füsse Höhe	pieds hauteur	feet height	10
<b>Palermo XL</b>	Kopfteil	tête de lit	headboard	160, 180, 200
<b>Drell Topper</b>	Matratze Topper Breiten Längen	matelas surmatelas largeurs longueurs	mattress mattress topper widths lengths	80, 90, 100, 160, 180, 200 200, 210, 220

**Alle Polsterteile in Casual carbon 334** | toutes les parties rembourrées en Casual carbon 334 | all upholstery parts in Casual carbon 334  
**Alle Holzteile in Wildeiche natur, gebürstet, geölt** | toutes les parties en bois en chêne nouveau naturel, brossé, huilé | all wooden parts in wildoak natural, brushed, oiled  
**Weitere Beimöbel siehe Register 1** | davantage d'accessoires voir registre 1 | other accessories see index 1

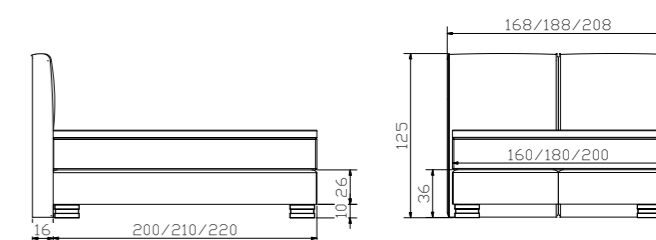



				Dimension cm
<b>Claudio iron</b>	Herrendiener	valet	dressboy	45/28/107
<b>Cerina</b>	Nachttisch	table de nuit	bedside table	48/45/57
<b>Seca iron</b>	Griffe (3-er Set)	poignées (set de 3)	handles (set of 3)	

				Dimension cm
<b>Classic-Box 26</b>	Untergestell Breiten Längen	sommier largeurs longueurs	mattress base widths lengths	90, 100, 120, 140, 160, 180, 200 200, 210, 220
<b>Mico iron</b>	Füsse Höhe	pieds hauteur	feet height	10
<b>Nizza L</b>	Kopfteil	tête de lit	headboard	90, 100, 120, 140, 160, 180, 200
<b>Tex Topper</b>	Matratze Topper Breiten Längen	matelas surmatelas largeurs longueurs	mattress mattress topper widths lengths	80, 90, 100, 120, 140, 160, 180, 200 200, 210, 220

**Alle Polsterteile in Casual cognac 332** | toutes les parties rembourrées en Casual cognac 332 | all upholstery parts in Casual cognac 332

**Alle Holzteile in Wildeiche natur, gebürstet, geölt** | toutes les parties en bois en chêne nouveau naturel, brossé, huilé | all wooden parts in wildoak natural, brushed, oiled

**Weitere Beimöbel siehe Register 1** | davantage d'accessoires voir registre 1 | other accessories see index 1

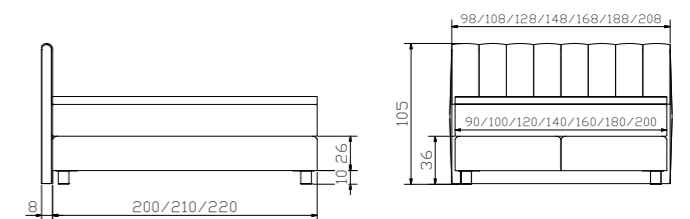



				Dimension cm
<b>Chest</b>	Kommode Korpus MDF betonfarbig lackiert	commode corps en mdf teinté beton, laqué	chest of drawers corpus in mdf concrete coloured, lacquered	105/49/76
<b>Scola</b>	Sekretär höhenverstellbar	secrétaire réglable en hauteur	bureau adjustable in height	120/70/72-88
<b>Tree</b>	Nachttisch/Hocker Echtbeton grey	table de nuit/tabouret béton véritable grey	bedside table/stool real concrete grey	Ø 42/44
<b>Tercio</b>	Nachttisch/Rollcontainer	table de nuit/caisson à roulettes	bedside table/rolling container	53/41/58

				Dimension cm
<b>Classic-Box 26</b>	Untergestell Breiten Längen	sommier largeurs longueurs	mattress base widths lengths	140, 160, 180, 200 200, 210, 220
<b>Ivio</b>	Füße Höhe	pieds hauteur	feet height	10
<b>Ohio</b>	Kopfteil	tête de lit	headboard	140, 160, 180, 200
<b>Tex Topper</b>	Matratze Topper Breiten Längen	matelas surmatelas largeurs longueurs	mattress mattress topper widths lengths	80, 90, 100, 140, 160, 180, 200 200, 210, 220

**Alle Polsterteile in Shine opal 682** | toutes les parties rembourrées en Shine opal 682 | all upholstery parts in Shine opal 682  
**Alle Holzteile in Akazie Vintage grey** | toutes les parties en bois en acacia vintage grey | all wooden parts in acacia vintage grey  
**Weitere Beimöbel siehe Register 1** | davantage d'accessoires voir registre 1 | other accessories see index 1

