



swiss bed concept



NATURO LINE

MASSIVHOLZ | BOIS MASSIF | SOLID WOOD

Achten Sie auf FSC®-zertifizierte Produkte | Soyez attentifs aux produits certifiés FSC® | Look for FSC®-certified products

Bettrahmen | Cadre de lit | Bedframe



Connecto 23



Breiten | Largeurs | Widths:
140, 160, 180, 200 cm

Längen | Longueurs | Lengths:
200, 210, 220 cm

Einlegetiefe | Hauteur encastrable | Insertion depth:
18*, 23 cm



Ausführungen | Exécutions | Executions

Holz | Bois | Wood



87 Wildbuche natur, geölt
Hêtre nouveaux naturel, huilé
Wildbeech natural, oiled



96 Wildeiche pure, gebürstet, geölt
Chêne nouveaux pure, brossé, huilé
Wildoak pure, brushed, oiled



Traversen | Traverses | Bars



Wir empfehlen grundsätzlich den Einsatz von Crosstraver (Quertraverse) oder Midtraver (Längstraverse).
 Nous recommandons en général l'utilisation de Crosstraver (traverse transversale) ou Midtraver (traverse centrale).
 We recommend basically the insertion of Crosstraver (central cross bar) or Midtraver (central bar).

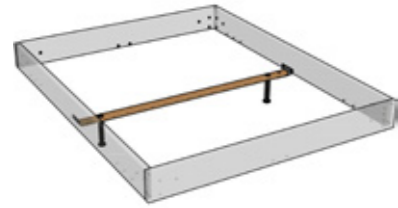

Crosstraver
 Quertraverse | Traverse transversale | Central cross bar

Für alle Bettbreiten | Pour toutes les largeurs de lit | For all bed widths

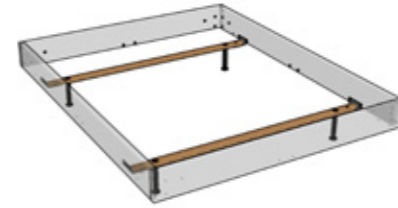

Crosstraver-Twin
 Quertraversen | Traverses transversales | Cross bars

Für alle Bettbreiten | Pour toutes les largeurs de lit | For all bed widths

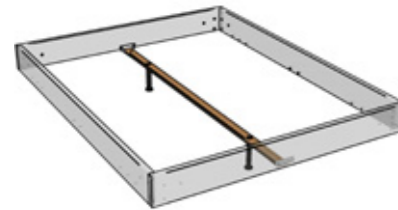

Midtraver
 Längstraverse | Traverse centrale | Central bar

Für Betten ab Breite 140 cm mit 2 Lattenrosten oder Motorrahmen-einbau | Pour les lits à partir de 140 cm de largeur avec 2 sommiers ou l'installation d'un cadre motorisé | For beds from 140 cm width with 2 slats or motor frame installation

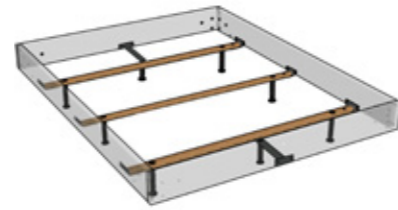

Crosstraver-XXL
 Quertraversen | Traverses transversales | Cross bars

Für alle Bettbreiten | Pour toutes les largeurs de lit | For all bed widths

Übersicht Kompatibilität Traversen siehe Seite 2.12 | Aperçu compatibilité traverses voir page 2.12 | Overview compatibility bars see page 2.12

*** Connecto 23**

Bei der Einlegetiefe 18 cm sind die Füße/Sockel um 5 cm versenkt und um diese Höhe weniger sichtbar.

Avec les équerres en position haute (18 cm) les pieds/socle sont encastrés de 5 cm sous le cadre et donc moins visibles.

With the insertion depth 18 cm the feet/socket are sunken in by 5 cm and this height less visible.

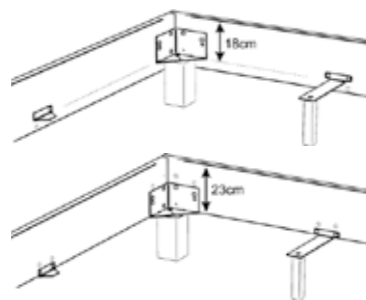

Option Midtraver-move + Evio

Achtung: nicht bei Füßen in der Höhe 30 cm, Lovie-Box und Practico-Box einsetzbar

Attention : ne s'applique pas aux pieds à une hauteur de 30 cm, Lovie-Box et Practico-Box

Attention: not applicable for feet at a height of 30 cm, Lovie-Box and Practico-Box

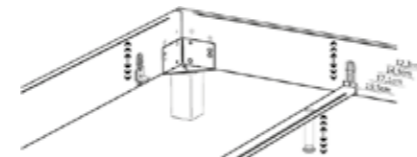

Ausführungen | Exécutions | Executions

Holz | Bois | Wood



10 Buche weiss deckend, lackiert
 Hêtre blanc couvrant, laqué
 Beech white covered, lacquered

16 Buche anthracit deckend, lackiert
 Hêtre anthracite couvrant, laqué
 Beech anthracit covered, lacquered

87 Wildbuche natur, geölt
 Hêtre nouveau naturel, huilé
 Wildbeech natural, oiled

96 Wildeiche pure, gebürstet, geölt
 Chêne nouveau pure, brossé, huilé
 Wildoak pure, brushed, oiled

Füsse | Pieds | Feet



Holz | Bois | Wood



Holz Bois Wood	Breiten cm Largeurs cm Widths cm	Höhen cm Hauteurs cm Heights cm			Holzfarben Couleurs bois Colours wood			
		20	25	30	10	16	87	96
Gola		●	●				●	●
Evio	140-200		●				●	●
Ivio		●	●	●			●	●
Lovie-Box	140-200		●				●	●
Practico Box* (inkl. Boden/fond inclus/ bottom included)	140-200		●		●	●		
Skid	140-200		●				●	●

*weiss/anthrazit = MDF | blanc/anthracite = MDF | white/anthracite = MDF

Metall | Métal | Metal

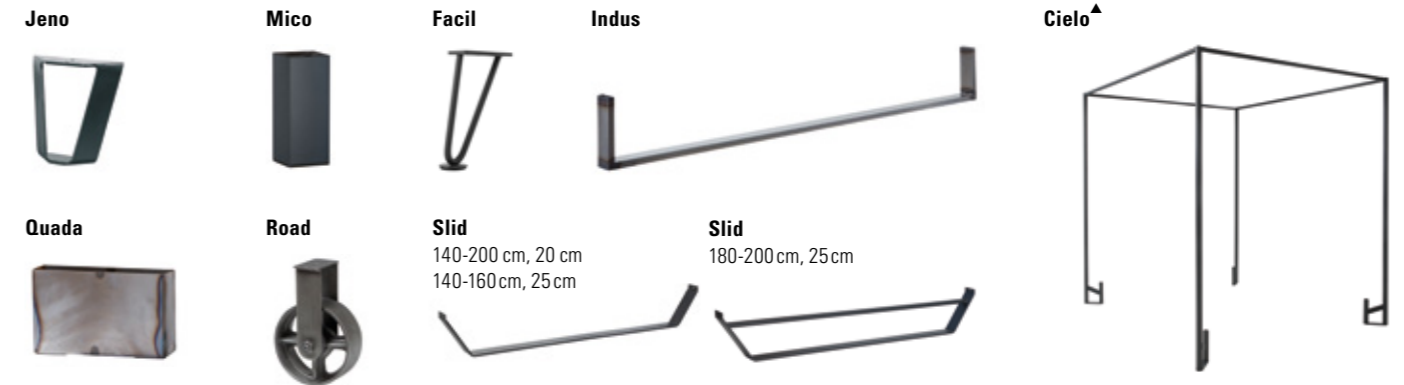

Metall Métal Metal	Masse cm Dimensions cm	Breiten cm Largeurs cm Widths cm	Höhen cm Hauteurs cm Heights cm				Metallfarben Couleurs métal Colours metal							
			10	20	25	30	00	04	10	16	42	43	45	
Cielo [▲]		140-200		●				●	●					
Facil				●										
Indus		140-200												●
Jeno	12x5		●	●	●				●					
Mico	8x8		●	●	●	●			●		●	●	●	●
Quada	20x6,5			●	●									●
Road*	Ø 13			●					●					
Slid	8/1	140-200		●	●					●	●	●		

*Füsse fixiert, Rollen nur optisch | Pieds fixes, roulettes uniquement décoration | Feet fixed, castors only visua

[▲]Curty Vorhang und Vela Baldachin-Tuch siehe Register 2, Seite 12 | Curty rideau et Vela tissu de baldaquin voir registre 2, page 12 | Curty curtain and Vela canopy cloth see index 2, page 12



00 Chrom = Metall verchromt | Métal chromé | Metal chrome

04 Used = Metall galvanisiert | Métal galvanisé | Metal galvanised

10 White = Metall pulverbeschichtet | Métal thermolaqué | Metal powder-coated

16 Anthracit = Metall pulverbeschichtet | Métal thermolaqué | Metal powder-coated

42 Alu = Stahl pulverbeschichtet | Acier thermolaqué | Steel powder-coated

43 Inox = Edelstahl geschliffen | Acier inoxydable poncé | Stainless steel ground

45 Iron = Metall geflammt, pulverbeschichtet | Métal flammé, thermolaqué | Metal mottled, powder-coated

Bettkasten mit Holzkufen | Tiroirs de lit avec patins en bois | Bed drawers with wooden vat



Lovie-Box + Covero
90-140 cm 1 Schublade | 1 Tiroir | 1 Drawer

Lovie-Box + Saceto
140-200 cm 2 Schubladen | 2 Tiroirs | 2 Drawers

Stauraum | Compartiment de rangement | Storage space: 134 × 61 × 16 cm

Stauraum | Compartiment de rangement | Storage space: 2 × 134 × 61 × 16 cm

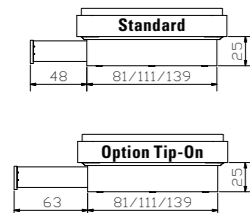

Standard: gedämpfter Selbsteinzug Blumotion von BLUM | système d'amortissement Blumotion de BLUM | soft closing runner Blumotion of BLUM

Option: Tip-On-Öffnung mit Vollauszug von BLUM | ouverture Tip-On avec sortie totale de BLUM | opening Tip-On with full extension of BLUM

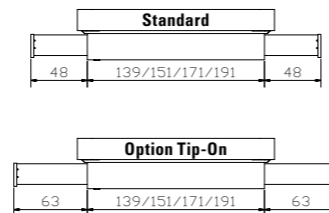

Roll-Box 20/25

Roll-Box 20/25 + Covero

Roll-Box 20/25 + Saceto



Bettkasten in weiss oder anthrazit (Boden weiss)

Tiroir de lit en blanc ou anthracite (fond blanc)

Bed drawer in white or anthracite (bottom white)

Voraussetzung

Bettfusshöhe von mindestens 20cm erforderlich

Condition préalable

Une hauteur de pieds de lit d'au moins 20 cm est nécessaire

Condition

Feet of bed need a minimum height of 20 cm

Optionen

Deckel Covero in weiss, Stoffabdeckung Saceto in Polyester grau.

Options

Couvercle Covero en blanc, tissu de protection Saceto en polyester gris.

Options

Covero in white, tissue of protection Saceto in polyester grey.



Roll-Box 20



Roll-Box 25

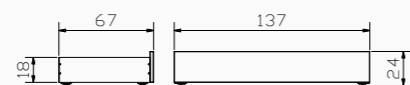

Stauraum | Espace de rangement | Storage space

Roll-Box 20	=	134 × 61 × 13 cm
Roll-Box 25	=	134 × 61 × 16 cm

Bettkasten | Coffres à literie | Bedding boxes

Practico-Box + Connecto 23 + Ultrafree-Lift KF

Practico-Box + Connecto 23 + Econom-move



Ultrafree-Lift KF



Econom-move



Box = inkl. Boden, Anwendung siehe Seiten 9.20–9.21

zu Practico-Box:

Lattenrost **Ultrafree-Lift KF**
Kopf-/Fussverstellung
Rahmenholme Höhe 7 cm und 28 Federleisten aus Buchenschichtholz
Gesamthöhe 11 cm

Box = fond inclus, utilisation voir pages 9.20–9.21

pour box Practico:

Sommier **Ultrafree-Lift KF**
Tête et pied réglables
Cadre, hauteur 7 cm et 28 lattes en hêtre multiplis
Hauteur totale 11 cm

Lattenrost **Econom-move**

Unverstellbar
Rahmenholme Höhe 6 cm und 28 Federleisten aus Buchenschichtholz
Gesamthöhe 9 cm

Sommier **Econom-move**

Non réglable
Cadre, hauteur 6 cm et 28 lattes en hêtre multiplis
Hauteur totale 9 cm

inkl. Gasdruckfedern und allen Beschlägen

Pistons à gaz et toute la quincaillerie inclus

Details zu Ultrafree-Lift KF und Econom-move siehe Register 14, Seite 14.8

Détails pour Ultrafree-Lift KF et Econom-move voir registre 14, page 14.8

Stauraum | Compartiment de rangement | Storage space

140 × 200/210/220	=	131 × 190/200/210 × 24 cm
160 × 200/210/220	=	74 × 190/200/210 × 24 (2 x) cm
180 × 200/210/220	=	84 × 190/200/210 × 24 (2 x) cm
200 × 200/210/220	=	94 × 190/200/210 × 24 (2 x) cm

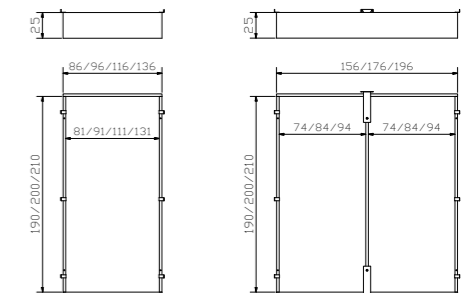

Box = bottom incl., handling see pages 9.20–9.21

for Practico-box:

Slats **Ultrafree-Lift KF**
Head/footpiece adjustable
Frame, height 7 cm and 28 slats are of beech veneer board
Total height 11 cm

Slats **Econom-move**

Not adjustable
Frame, height 6 cm and 28 slats are of beech veneer board
Total height 9 cm

Pneumatic compression spring and all fittings included

Details for Ultrafree-Lift KF and Econom-move see index 14, pages 14.8

Himmelbett ohne Grenzen

Lit à baldachin sans frontières | Canopy bed without borders

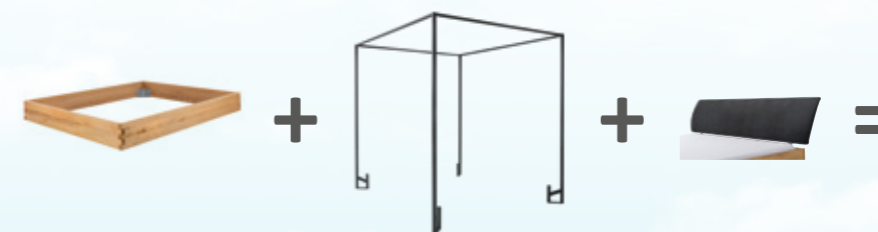

Betrahmen
Cadre de lit | Bedframe

Cielo
Baldachin | Baldachin | Canopy

Kopfteil
Tête de lit | Headboard



Kopfteile | Têtes de lit | Headboards



Bordo



Dimension: 140, 160, 180, 200

Naturo L



Dimension: 140, 160, 180, 200

Bretto



Dimension: 140, 160, 180, 200

Adapter | Adaptateur | Adapter

Bei hohen Matratzen kann mit dem Verlängerungsadapter das Kopfteil erhöht werden.

La tête de lit peut être rehaussée avec l'adaptateur lorsque le matelas est plus épais.

With the extension adapter the headboard can be extended if mattresses are high.

Head-Plus (2er Set | set de 2 | set of 2)

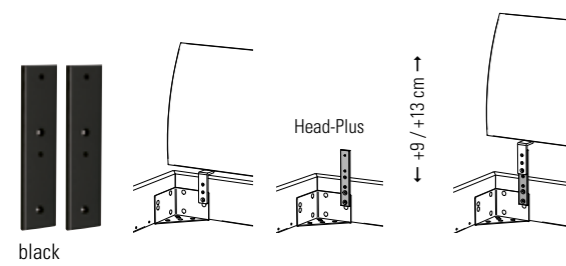

black

Leselampe | Lampe de lecture | Reading lamp

Leselampe bei Holz- und gepolsterten Kopfteilen montierbar

La lampe de lecture peut être montée sur des têtes de lit en bois et rembourrée
Reading lamp can be assembled on wooden an upholstered headboards

Smart black (2er Set | set de 2 | set of 2)



Weitere Leselampen und technische Details siehe Register 2, Seite 2.11

Autres lampes de lecture et détails techniques voir registre 2, page 2.11
Further reading lamps and technical details see index 2, page 2.11

Ausführungen | Exécutions | Executions

Holz | Bois | Wood



87
Wildbuche natur, geölt
Hêtre nouveau naturel, huilé
Wildbeech natural, oiled

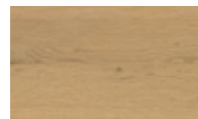

96
Wildeiche pure, gebürstet, geölt
Chêne nouveau pure, brossé, huilé
Wildoak pure, brushed, oiled

Kissen zu Kopfteilen | Coussins pour têtes de lit | Cushions for headboards

Arona + Naturo L



Ravo + Bordo



Varo + Bretto



Lumo + Naturo L



Suny + Bordo



Alle Kissen in Echtleder haben Zier- sowie Teilungsnahte. Ausnahmen: Suny und Varo, diese Kissen haben lediglich Ziernahte. | Tous les coussins en cuir véritable ont des coutures décoratives et des coutures de séparation. A l'exception des coussins : Suny et Varo, ces coussins ont uniquement des coutures décoratives. | All cushions in genuine leather have decorative and dividing seams. Exceptions: Suny and Varo, these cushions only have decorative seams.

Kissen | Coussins | Cushions

	Effektive Masse cm Dimensions effectives cm Effective dimensions cm
Arona	136, 156, 176×3,5×25
Lumo	136, 156, 176×6×25
Ravo	130, 150, 170, 190×3,5×35
Suny (2er Set set de 2 set of 2)	55×6×40
Varo (2er Set set de 2 set of 2)	55×10×35

zu Kopfteilen pour têtes de lit for headboards

	Bordo	Bretto	Naturo
			●
			●
	●	●	
	●		
	●	●	

Breitenmasse cm Dimensions de largeur cm Widths dimensions cm

140, 160, 180/200
140, 160, 180/200
140, 160, 180, 200

gepolstert | rembourrées | upholstered

Suno



Dimension: 140, 160, 180, 200

Ripo

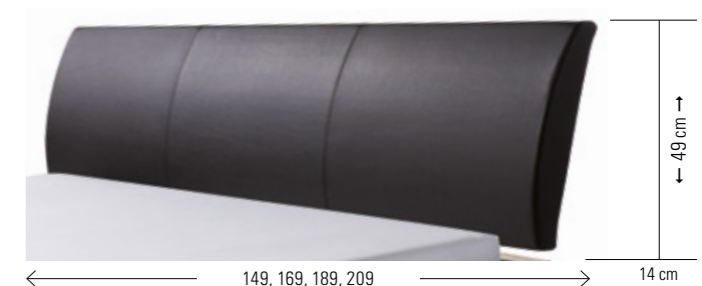

Dimension: 140, 160, 180, 200

Weitere gepolsterte Kopfteile, Wandpaneele, Stoffauswahl/Farben siehe Register 1, Leselampen siehe Register 2

Autres têtes de lits rembourrées, panneaux muraux, choix de tissus/couleurs voir registre 1, lampes de lecture voir registre 2
Further upholstered headboards, wallpanels, choice of tissues/colours see index 1, reading lamps see index 2

Nachttische, Kommoden | Tables de nuit, commodes | Bedside tables, chests of drawers

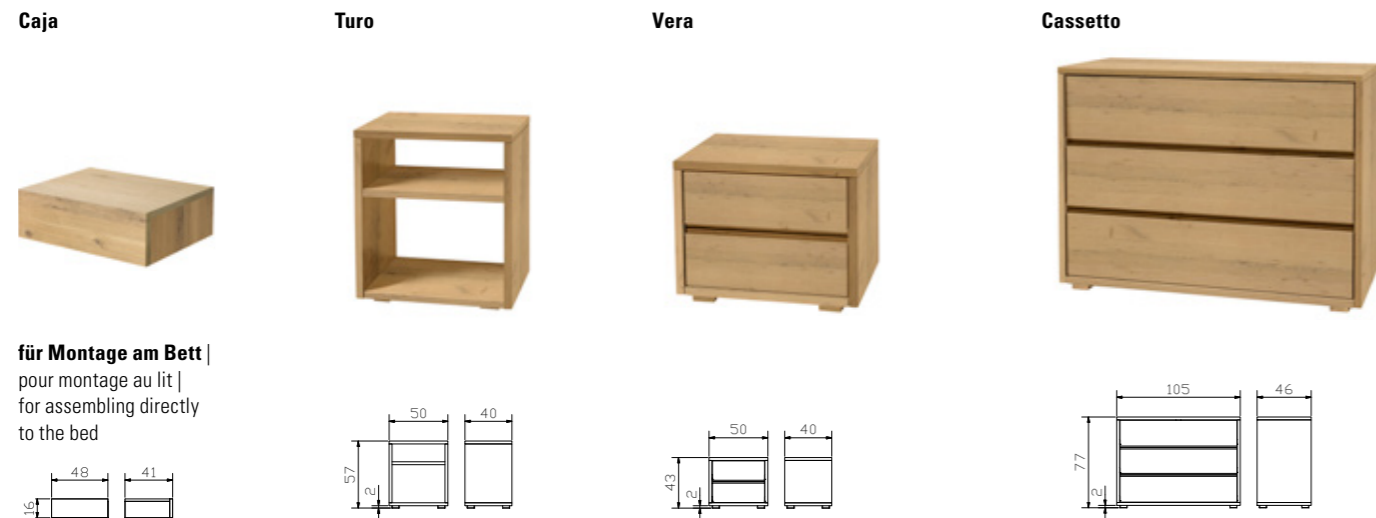

für Montage am Bett |
pour montage au lit |
for assembling directly
to the bed

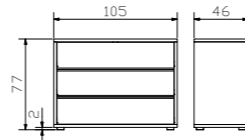
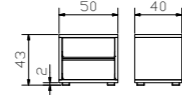
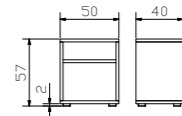
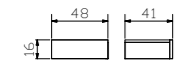

Zubehör, Beimöbel | Accessoires | Accessories

Füsse | Pieds | Feet = Option zu | pour | for Cassetto, Turo, Vera

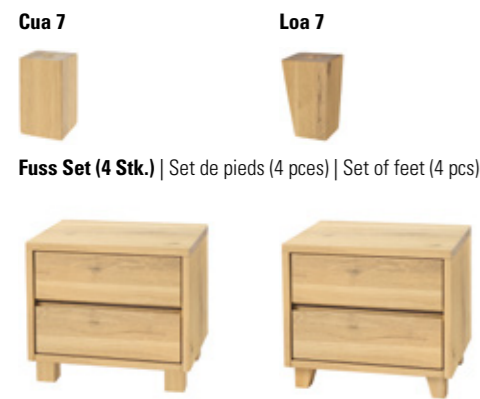

Fuss Set (4 Stk.) | Set de pieds (4 pcs) | Set of feet (4 pcs)

Herrendiener | Valet | Dressboy

Claudio alu, anthracit, iron

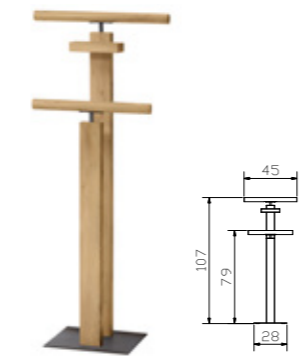

Bank + Kissen | Banquette + Coussin | Bench + Cushion

Calmo

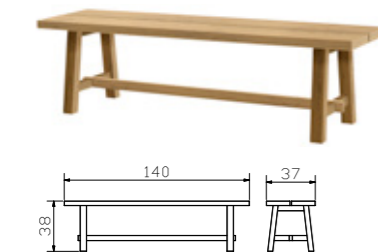

Topia

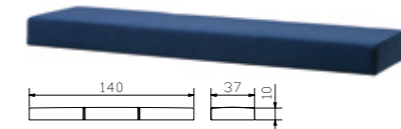

Vano

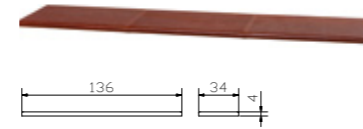

Vano, Topia
Stoffauswahl siehe Register 1, Seiten 6 - 7 | Choix de tissus voir registre 1, pages 6 - 7 | Choice of
tissues see index 1, pages 6 - 7

Blumotion



**Für unsere Nachttische und Kommoden verwenden wir ausschliesslich den gedämpften Selbst-
einzug Blumotion von BLUM.**

Pour nos tables de nuit et commodes nous utilisons exclusivement les tiroirs avec système d'amortissement
Blumotion de BLUM.

For our bedside tables and chests of drawers we utilize exclusively the silent and soft self closing drawer
runner Blumotion of BLUM.

Ausführungen | Exécutions | Executions

Holz | Bois | Wood



87
Wildbuche natur, geölt
Hêtre nouveaux naturel, huilé
Wildbeech natural, oiled



Mit der Wildbuche holen Sie sich ein Stück leidenschaftliche, ungebändigte Natur in Ihr Schlafzimmer. Für diese besonderen Möbelstücke verwenden wir massive Wildbuche, die jahrzehntlang bis zur vollkommenen Reife gewachsen ist. Dabei setzen wir ganz bewusst auf mit Markstrahlen und Ästen versehene Hölzer, um den individuellen, wilden Charakter dieses Naturholzes zu unterstreichen.

Avec le hêtre nouveaux, vous apportez un bout de nature passionnée et indomptée dans votre chambre à coucher. Pour ces meubles spéciaux, nous utilisons du hêtre nouveaux massif qui a atteint une maturité parfaite au fil des décennies. Nous utilisons délibérément du bois avec des nervures et des nœuds pour souligner le caractère individuel et sauvage de ce bois naturel.

With wildbeech, you bring a piece of passionate, untamed nature into your bedroom. For these special pieces of furniture, we use solid wild beech that has grown to perfect maturity over decades. We deliberately use wood with medullary rays and limbs to achieve the individual, wild character of this natural wood.



96
Wildeiche pure, gebürstet, geölt
Chêne nouveaux pure, brossé, huilé
Wildoak pure, brushed, oiled

Zeitlos schön und unaufdringlich – Der helle, dezente Farbton der «Wildeiche pure» lässt die typisch kräftige Struktur des Eichenholzes ruhiger erscheinen. Die natürliche Haptik des Holzes wird durch die Behandlung des Bürstens verstärkt. Die Maserung wird fühlbar. Möbelstücke in dieser Ausführung wirken leicht und sanft, kleine Wohnräume gewinnen mit ihnen optisch an Weite. «Wildeiche pure» schenkt ihrem Schlafzimmer eine natürliche Leichtigkeit und ruhevolle Ausstrahlung.

Une beauté intemporelle et discrète – La teinte claire et subtile du « chêne nouveaux pure » apporte une atmosphère plus calme à la structure généralement forte du bois de chêne. La sensation naturelle du bois est renforcée par le traitement au pinceau. Le grain devient perceptible. Les meubles dans cette finition semblent légers et doux, les petits espaces gagnent visuellement de l'ampleur avec eux. Le « Chêne nouveaux pure » donne à votre chambre une légèreté naturelle et une aura paisible.

Timelessly beautiful and unobtrusive – The light, discreet shade of «wildoak pure» makes the typically strong structure of oak appear calmer. The natural feel of the wood is increased by the brushing treatment. The grain becomes tangible. Pieces of furniture in this finish appear light and gentle; small living rooms visually gain in width with them. «Wildoak pure» gives your bedroom a natural lightness and a peaceful aura.



Lattenroste | Sommier | Slats



Dritto U

U = Unverstellbar
Non réglable
Not adjustable

Rahmenholme und 14 Federleisten aus Buchenschichtholz
Cadre et 14 lattes en hêtre multiplis
Frame and 14 slats are of beech veneer board

Starre Lagerung
Suspension rigide
Rigid suspension

Längen | Longueurs | Lengths

200

Höhe | Hauteur | Height: 6 cm

Keine Sondermasse möglich | Dimensions spéciales non disponibles |
No special sizes possible

Breiten | Largeurs | Widths

80	90	100	140
●	●	●	●



Flexo K

K = Kopfteil manuell 13-fach verstellbar
Réglage manuel de la tête en 13 positions
Head piece manually adjustable in 13 positions

Rahmenholme und 28 Federleisten aus Buchenschichtholz
Cadre et 28 lattes en hêtre multiplis
Frame and 28 slats are of beech veneer board

Flexible Lagerung
Suspension flexible
Flexible suspension

Schulterkomfortzone
Zone de confort des épaules
Comfort zone for shoulders

Mittelzonenverstärkung
Zone médiane renforcée
Reinforcement of the middle zone

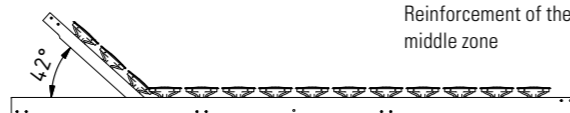

Längen | Longueurs | Lengths

200, 210, 220

Höhe | Hauteur | Height: 9 cm

Keine Sondermasse möglich | Dimensions spéciales non disponibles |
No special sizes possible

Breiten | Largeurs | Widths

80	90	100	140
●	●	●	●



Ultrafree RF

RF = Rücken- und Fussteil manuell je 13-fach verstellbar
Réglage manuel pour le haut du corps et les jambes en 13 positions
Back and foot sections manually adjustable in 13 positions

Rahmenholme und 30 Federleisten aus Buchenschichtholz
Cadre et 30 lattes en hêtre multiplis
Frame and 30 slats are of beech veneer board

Details siehe Seite 14.2-14.3
Détails voir page
Details see page:

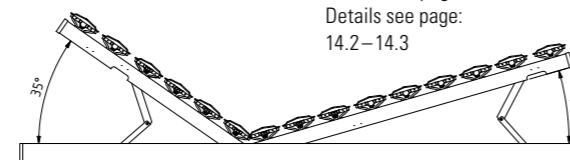

Längen | Longueurs | Lengths

200, 210, 220

Höhe | Hauteur | Height: 10 cm

Keine Sondermasse möglich | Dimensions spéciales non disponibles |
No special sizes possible

Breiten | Largeurs | Widths

80	90	100	140
●	●	●	●

Matratzen | Matelas | Mattresses

Novo

7-Zonen-Kaltschaumkern, Höhe 8 cm in Härtegrad H3 (RG 35) erhältlich
7-zones noyau en mousse froide, hauteur 8 cm disponible dans le degré de fermeté f3 (densité 35)
7-zones core cold foam, height 8 cm available in the degree of hardness H3 (density 35)

Optimale Unterstützung durch 7-Zonen-Kaltschaum-Noppenprofil in 2.5 cm Stärke
Soutien optimal grâce à une mousse 7-zones froide à picots 2.5 cm
Optimum support through 7-zones cold foam upholstery 2.5 cm with nobs

Breiten | Largeurs | Widths 80, 90, 100, 140, 160, 180, 200 cm

Längen | Longueurs | Lengths 200, 210, 220 cm

Höhe | Hauteur | Height 16 cm

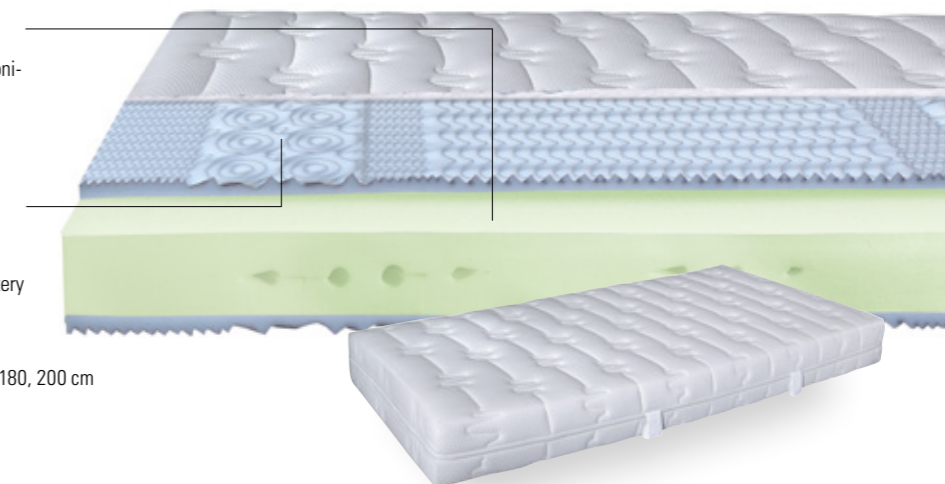

Ultraconfort

7-Zonen-Kaltschaumkern, Höhe 12 cm in den Härtegraden H3 (RG 45) und H4 (RG 50) erhältlich
7-zones noyau en mousse froide, hauteur 12 cm disponible dans les degrés de fermeté f3 (densité 45) et f4 (densité 50)
7-zones core cold foam, height 12 cm available in the degrees of hardness H3 (density 45) and H4 (density 50)

Optimale Unterstützung und Klimatisierung durch 4 cm Soft-Kaltschaum-Auflage RG 60
Soutien optimal et climatisation idéale grâce à une mousse froide souple 4 cm densité 60
Optimum support and climate regulation through 4 cm soft cold foam upholstery density 60

Breiten | Largeurs | Widths 80, 90, 100, 140, 160, 180, 200 cm

Längen | Longueurs | Lengths 190, 200, 210, 220 cm

Höhe | Hauteur | Height 21 cm

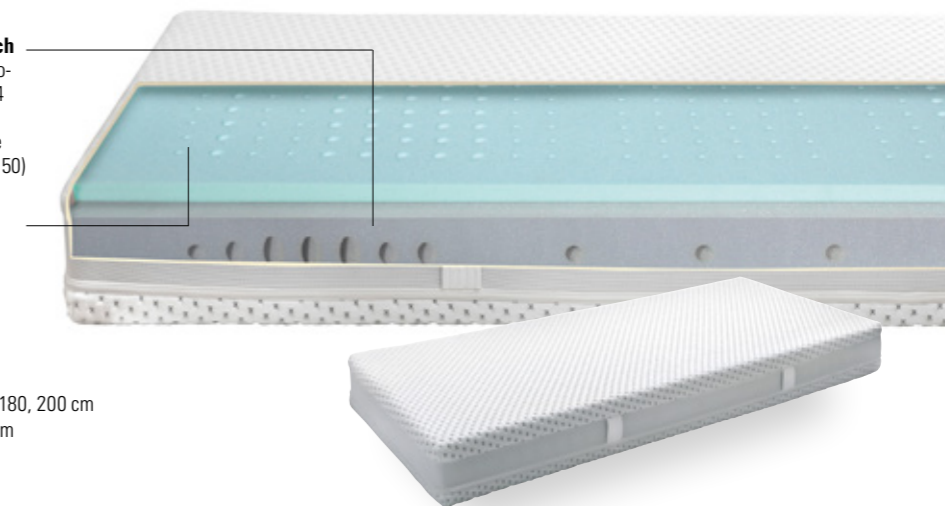

Ultramotion

7-Zonen-Kaltschaum-Tröpfchenkern mit Querbelüftung und Schulterzone, Höhe 20 cm in den Härtegraden H2 (RG 53), H3 (RG 53) und H4 (RG 45) erhältlich

7-zones noyau de gouttelettes en mousse froide avec ventilation transversale et zone pour les épaules, hauteur 20 cm disponible dans les degrés de fermeté f2 (densité 53), f3 (densité 53) et f4 (densité 45)
7-zones cold foam droplet core with lateral ventilation and shoulder zone, height 20 cm available in the degrees of hardness H2 (density 53), H3 (density 53) and H4 (density 45)

Breiten | Largeurs | Widths 80, 90, 100, 140, 160, 180, 200 cm

Längen | Longueurs | Lengths 190, 200, 210, 220 cm

Höhe | Hauteur | Height 23 cm



Informationen zu Matratzenbezügen und weitere Lattenroste und Matratzen siehe Register 14

Informations sur les housses de matelas et autres sommiers et matelas, voir registre 14
Information on mattress covers and other slatted frames and mattresses, see index 14



				Dimension cm
Claudio anthracit	Herrendiener	Valet	Dressboy	45/28/107
Turo	Nachttisch	Table de nuit	Bedside table	50/40/57
Vera	Nachttisch	Table de nuit	Bedside table	50/40/43
Curty	Baldachin-Vorhang (3er Set) Baumwolle weiss	Rideau de baldaquin (set de 3) coton blanc	Curtain of canopy (set of 3) cotton white	272/185 (3x)

				Dimension cm
Connecto 23	Rahmen Breiten Längen	Cadre Largeurs Longueurs	Frame Widths Lengths	140, 160, 180, 200 200, 210, 220
Cielo anthracit	Baldachin Breiten Höhen	Baldaquin Largeurs Hauteurs	Canopy Widths Heights	140, 160, 180, 200 20
Bordo	Kopfteil	Tête de lit	Headboard	140, 160, 180, 200

Alle Holzteile in Wildbuche natur, geölt | Toutes les parties en bois hêtre nouveau naturel, huilé | All wooden parts in wildbeech natural, oiled
 Weitere Beimöbel siehe Register 2 | Autres accessoires voir registre 2 | Further accessories see index 2

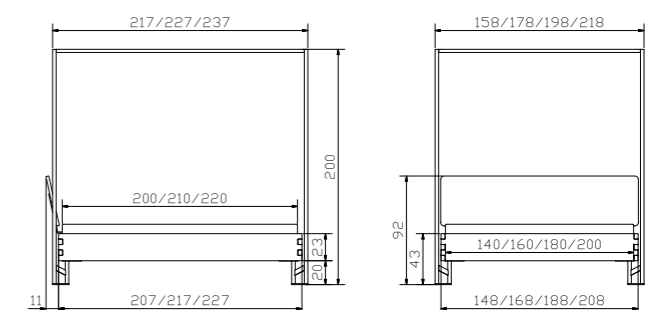



Dimension cm

Cassetto	Kommode	Commode	Chest of drawers	105/46/77
Vera	Nachttisch	Table de nuit	Bedside table	50/40/43

Dimension cm

Connecto 23	Rahmen Breiten Längen	Cadre Largeurs Longueurs	Frame Widths Lengths	140, 160, 180, 200 200, 210, 220
Skid	Kufen Breiten Höhe	Patins Largeurs Hauteur	Vats Widths Height	140, 160, 180, 200 25
Bretto	Kopfteil	Tête de lit	Headboard	140, 160, 180, 200



Alle Holzteile in Wildbuche natur, geölt
 Toutes les parties en bois hêtre naturel, huilé
 All wooden parts in wildbeech natural, oiled

Weitere Beimöbel siehe Register 2
 Autres accessoires voir registre 2
 Further accessories see index 2

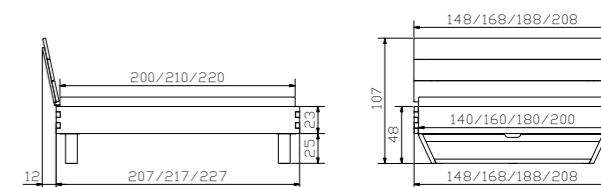



				Dimension cm
Naturo L	Kopfteil	Tête de lit	Headboard	140, 160, 180, 200
Arona	Kissen, Casual carbon 334	Coussin, Casual carbon 334	Cussion, Casual carbon 334	140, 160, 180/200
Smart black	Leselampe (2er Set), weiss 12V DC, 30 LED warm Dreistufenschaltung	Lampe de lecture (set de 2), blanc 12V DC, 30 LED warm interrupteur à 3 crans	Reading lamp (set of 2), white 12V DC, 30 LED warm three step circuit	
Bordo	Kopfteil	Tête de lit	Headboard	140, 160, 180, 200

				Dimension cm
Connecto 23	Rahmen Breiten Längen	Cadre Largeurs Longueurs	Frame Widths Lengths	140, 160, 180, 200 200, 210, 220
Gola	Füsse Höhen	Pieds Hauteurs	Feet Heights	20, 25
Naturo L	Kopfteil	Tête de lit	Headboard	140, 160, 180, 200
Caja	Nachttisch	Table de nuit	Bedside table	48/41/16



Alle Holzteile in Wildbuche natur, geölt
Toutes les parties en bois en hêtre nouveau naturel, huilé
All wooden parts in wildbeech natural, oiled

Leselampen und weitere Beimöbel siehe Register 2
Lampes de lecture et autres accessoires voir registre 2
Reading lamps and further accessories see index 2

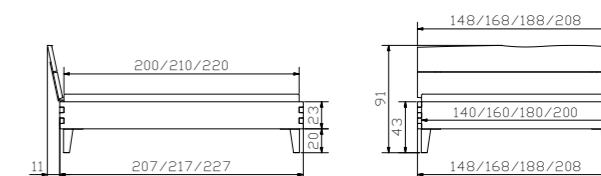



				Dimension cm
Cassetto	Kommode	Commode	Chest of drawers	105/46/77
Turo	Nachttisch	Table de nuit	Bedside table	50/40/57
Smart white	Leselampe (2er Set), weiss 12V DC, 30 LED warm Dreistufenschaltung	Lampe de lecture (set de 2), blanc 12V DC, 30 LED warm interrupteur à 3 crans	Reading lamp (set of 2), white 12V DC, 30 LED warm three step circuit	

				Dimension cm
Connecto 23	Rahmen Breiten Längen	Cadre Largeurs Longueurs	Frame Widths Lengths	140, 160, 180, 200 200, 210, 220
Practico-Box	Weiss Breiten Längen Höhe	Blanc Largeurs Longueur Hauteur	White Widths Lengths Height	140, 160, 180, 200 200, 210, 220 25
Bretto	Kopfteil	Tête de lit	Headboard	140, 160, 180, 200



Details siehe Seite 9.7
Détails voir page 9.7
Details see page 9.7

Alle Holzteile in Wildeiche pure, gebürstet, geölt
Toutes les parties en bois en chêne nouveau pure, brossé, huilé
All wooden parts in wildoak pure, brushed, oiled

Leselampen und weitere Beimöbel siehe Register 2
Lampes de lecture et autres accessoires voir registre 2
Reading lamps and further accessories see index 2

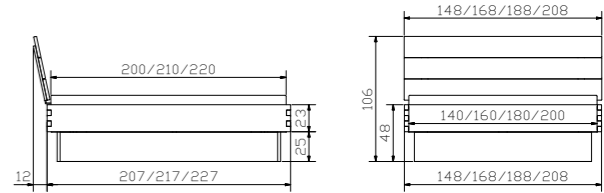



Snake alu	Leselampe (2er Set) 12V DC, 6 LED	Lampe de lecture (set de 2) 12V DC, 6 LED	Reading lamp (set of 2) 12V DC, 6 LED
------------------	--------------------------------------	--	--

Dimension cm

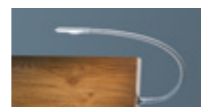

Caja	Nachttisch	Table de nuit	Bedside table	48/41/16
-------------	------------	---------------	---------------	----------

Connecto 23	Rahmen Breiten Längen	Cadre Largeurs Longueurs	Frame Widths Lengths	140, 160, 180, 200 200, 210, 220
Skid	Kufen Breiten Höhe	Patins Largeurs Hauteur	Vats Widths Height	140, 160, 180, 200 25
Naturo L	Kopfteil	Tête de lit	Headboard	140, 160, 180, 200
Cassetto	Kommode	Commode	Chest of drawers	105/46/77

Alle Holzteile in Wildeiche pure, gebürstet, geölt | Toutes les parties en bois en chêne nouveau pure, brossé, huilé | All wooden parts in wildoak pure, brushed, oiled
Leselampen und weitere Beimöbel siehe Register 2 | Lampes de lecture et autres accessoires voir registre 2 | Reading lamps and further accessories see index 2

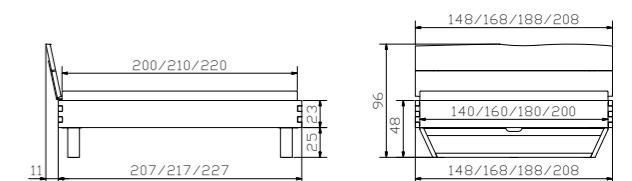



				Dimension cm
Bordo	Kopfteil	Tête de lit	Headboard	140, 160, 180, 200

				Dimension cm
Connecto 23	Rahmen Breiten Längen	Cadre Largeurs Longueurs	Frame Widths Lengths	140, 160, 180, 200 200, 210, 220
Gola	Füße Höhen	Pieds Hauteurs	Feet Heights	20, 25
Suno	Kopfteil, Velluto ivory 741	Tête de lit, Velluto ivory 741	Headboard, Velluto ivory 741	140, 160, 180, 200
Vera Loa 7	Nachttisch Füße	Table de nuit Pieds	Bedside table Feet	50/40/48
Claudio alu	Herrendiener	Valet	Dressboy	45/28/107
Calmo	Bank	Banquette	Bench	140/37/38



Alle Holzteile in Wildeiche pure, gebürstet, geölt
 Toutes les parties en bois en chêne nouveau pure, brossé, huilé
 All wooden parts in wildoak pure, brushed, oiled

Weitere Beimöbel siehe Register 2
 Autres accessoires voir registre 2
 Further accessories see index 2

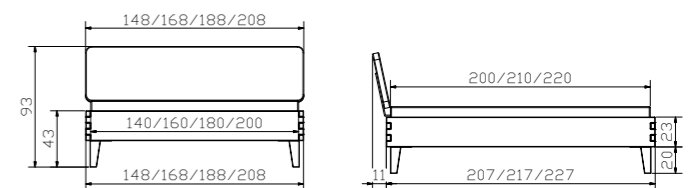



				Dimension cm
Vera	Nachttisch	Table de nuit	Bedside table	50/40/43
Cua 7	Füsse	Pieds	Feet	

				Dimension cm
Connecto 23	Rahmen Breiten Längen	Cadre Largeurs Longueurs	Frame Widths Lengths	140, 160, 180, 200 200, 210, 220
Gola	Füsse Höhen	Pieds Hauteurs	Feet Heights	20, 25, 30
Bretto	Kopfteil	Tête de lit	Headboard	140, 160, 180, 200

Alle Holzteile in Wildeiche pure, gebürstet, geölt | Toutes les parties en bois en chêne nouveau pure, brossé, huilé | All wooden parts in wildoak pure, brushed, oiled
Weitere Beimöbel siehe Register 2 | Autres accessoires voir registre 2 | Further accessories see index 2

