



swiss bed concept



# FACTORY LINE

**Akazie massiv** | acacia massiv | acacia solid

Achten Sie auf FSC®-zertifizierte Produkte | soyez attentifs aux produits certifiés FSC® | look for FSC®-certified products



The mark of responsible forestry



# Bettrahmen | cadre de lit | bedframe

## Bloc 16



**Breiten** | largeurs | widths:  
140, 160, 180, 200 cm

**Längen** | longueurs | lengths:  
200, 210, 220 cm

**Einlegetiefe** | hauteur encastrable | insertion depth:  
16 cm

## Loft 18\*



**Breiten** | largeurs | widths:  
90, 100, 120, 140, 160, 180, 200 cm

**Längen** | longueurs | lengths:  
200, 210, 220 cm

**Einlegetiefe** | hauteur encastrable | insertion depth:  
18 cm

## Dallas 23



**Breiten** | largeurs | widths:  
140, 160, 180, 200 cm

**Längen** | longueurs | lengths:  
200, 210, 220 cm

**Einlegetiefe** | hauteur encastrable | insertion depth:  
18\*\*, 23 cm

## \*Option | option



### Case 8

**Winkel (8er Set zu Loft Bettrahmen)**  
équerres (set de 8 pour cadre de lit Loft)  
bracket (set of 8 for Loft bedframe)

## Ausführungen | exécutions | executions

### Holz | bois | wood



**61 Akazie Vintage white, lackiert**

Acacia Vintage white, laqué  
Acacia Vintage white, lacquered

**62 Akazie Vintage brown, lackiert**

Acacia Vintage brown, laqué  
Acacia Vintage brown, lacquered

**64 Akazie Vintage grey, lackiert**

Acacia Vintage grey, laqué  
Acacia Vintage grey, lacquered

# Traversen | traverses | bars

**Wir empfehlen grundsätzlich den Einsatz von Crosstraver (Quertraverse) oder Midtraver (Längstraverse).**

Nous recommandons en général l'utilisation de Crosstraver (traverse transversale) ou Midtraver (traverse centrale).  
We recommend basically the insertion of Crosstraver (central cross bar) or Midtraver (central bar).

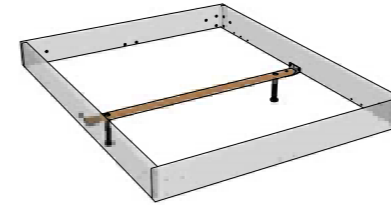

**Crosstraver**  
Quertraverse | traverse transversale | central cross bar

**Für alle Bettbreiten** | pour toutes les largeurs de lit | for all bed widths

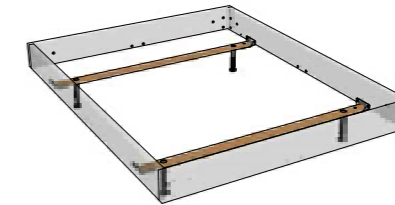

**Crosstraver-Twin**  
Quertraversen | traverses transversales | cross bars

**Für alle Bettbreiten** | pour toutes les largeurs de lit | for all bed widths

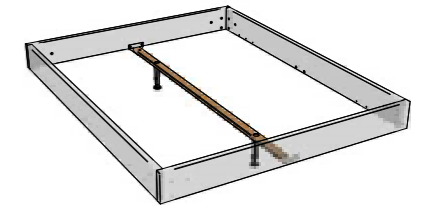

**Midtraver**  
Längstraverse | traverse centrale | central bar

**Für Betten ab Breite 160 cm mit 2 Lattenrosten oder Motorrahmeneinbau** | pour les lits à partir de 160 cm de largeur avec 2 sommiers ou l'installation d'un cadre motorisé | for beds from 160 cm width with 2 slats or motor frame installation

**Achtung: Crosstraver ist nicht mit den Füßen Lovie-Box und Practico-Box einsetzbar**

Attention : Crosstraver ne peut pas être utilisée avec les pieds Lovie-Box et Practico-Box  
Attention: Crosstraver cannot be used with the Lovie-Box and Practico-Box

**Achtung: Crosstraver-Twin ist nicht mit den Füßen Evio, Vilo, Lovie-Box und Practico-Box einsetzbar**

Attention : Crosstraver-Twin ne peut pas être utilisée avec les pieds Evio, Vilo, Lovie-Box et Practico-Box  
Attention: Crosstraver-Twin cannot be used with legs Evio, Vilo, Lovie-Box and Practico-Box

**Achtung: Midtraver ist nicht mit den Füßen Evio, Vilo, Lovie-Box und Practico-Box einsetzbar**

Attention : Midtraver ne peut pas être utilisée avec les pieds Evio, Vilo, Lovie-Box et Practico-Box  
Attention: Midtraver cannot be used with legs Evio, Vilo, Lovie-Box and Practico-Box

### \*\* Dallas 23

**Bei der Einlegetiefe 18 cm sind die Füße/ Sockel um 5 cm versenkt und um diese Höhe weniger sichtbar.**

Avec les équerres en position haute (18 cm) les pieds/ socle sont encastrés de 5 cm sous le cadre et donc moins visibles.

With the insertion depth 18 cm the feet/socket are sunken in by 5 cm and this height less visible.

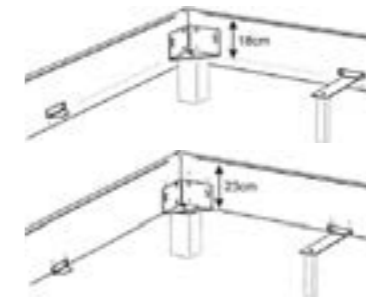

### Option Midtraver-move

**Achtung: nicht bei Füßen in der Höhe 30 cm, Lovie-Box und Practico-Box einsetzbar**

Attention : ne s'applique pas aux pieds à une hauteur de 30 cm, Lovie-Box et Practico-Box  
Attention: not applicable for feet at a height of 30 cm, Lovie-Box and Practico-Box

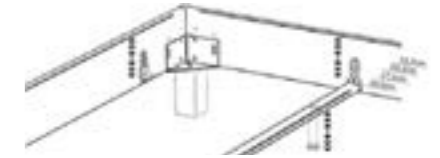

### Urbanes Flair

**Robust, schroff, mit dekorativen Metallbeschlägen und natürlichen Unregelmässigkeiten: der unkonventionelle Fabrikhallen-Stil unserer Factory-Line taucht jedes Schlafzimmer in ein aussergewöhnlich urbanes Flair.**

Alle Holzteile werden aus massiver Akazie gefertigt. Sie besitzt eine hohe Widerstandsfähigkeit und ist dadurch ein sehr dauerhaftes Holz. Neben dieser Robustheit verfügt Akazie über eine unvergleichliche Elastizität; Rissbildungen und Verziehen des Holzes kommen sehr selten vor.

Bitte beachten Sie, dass Farb- und Strukturunterschieden bei Echtholz naturbedingte Eigenschaften sind.

### Ambiance urbaine

**Robuste, rugueux, avec des ferrures décoratives en métal et des irrégularités naturelles : le style non conventionnel du hall d'usine de notre Factory-Line plonge chaque chambre dans une ambiance urbaine extraordinaire.**

Toutes les pièces en bois sont en acacia massif. Il a une haute résistance et est donc un bois très durable. En plus de cette robustesse, l'acacia possède une élasticité incomparable ; les fissures et les déformations du bois sont très rares.

Veillez noter que les différences de couleur et de structure sont des caractéristiques naturelles du bois.

### Urban flair

**Robust, rugged, with decorative metal fittings and natural irregularities: the unconventional factory hall style of our Factory-Line immerses every bedroom in an extraordinary urban flair.**

All wooden parts are made of solid acacia. It has a high resistance and is therefore a very durable wood. In addition to this robustness, acacia has an incomparable elasticity; cracking and warping of the wood occur very rarely.

Please note that differences in colour and texture are natural features of real wood.

# Füsse | pieds | feet

## Holz | bois | wood



**Standard: Blumotion**  
**Option: Tip-on**  
siehe Seite 5.8 | voir page 5.8 | see page 5.8

Holz   bois   wood	Masse cm dim. cm	Breiten cm largeurs cm widths cm	Höhen cm hauteurs cm heights cm				Holzfarben couleurs bois colours wood					
			10	20	25	30	10	16	61	62	64	
Evio		90–200			•		•	•				
Festo*	14×14			•	•			•	•	•		
Gola	8/5×8/5			•	•			•	•	•		
Ivio	10×10		•	•	•			•	•	•		
Lovie-Box* (1 Schublade/tiroir/drawer)		90–140			•		•	•				
Lovie-Box* (2 Schubladen/tiroirs/drawers)		140–200			•		•	•				
Practico-Box (inkl. Boden   fond inclus   bottom included)		90–200			•		•	•				
Stabil**		140–200			•			•	•	•		
Vilo		90–200		•			•	•				

\*bei Dallas 23 Rahmen nur mit Einlegetiefe 23 cm möglich | avec cadre Dallas 23 uniquement possible avec la hauteur encastrable de 23 cm | with Dallas 23 frame only possible with insertion depth 23 cm

\*\*Stabil nur mit Bloc 16 Rahmen möglich | Stabil uniquement possible avec cadre de lit Bloc16 | Stabil only possible with frame Bloc 16

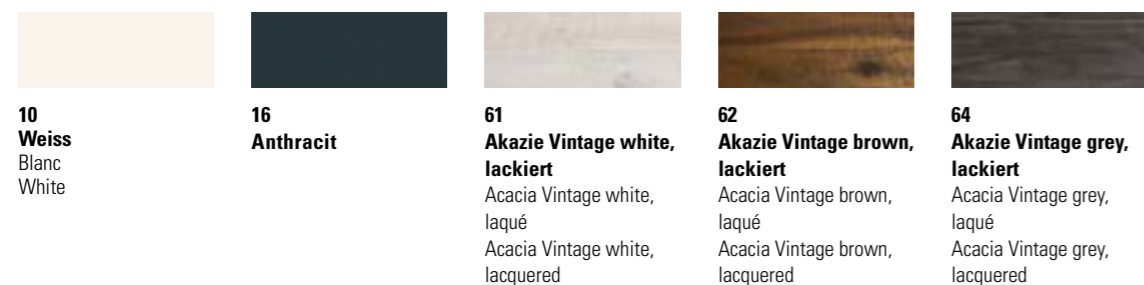

# Füsse | pieds | feet

## Metall | métal | metal



Metall   métal   metal	Masse cm dim. cm	Breiten cm largeurs cm widths cm	Höhen cm hauteurs cm heights cm				Metallfarben couleurs métal colours metal										
			10	20	25	30	00	04	10	16	40	41	42	43	45		
Caro	6×6		•	•	•		•										
Cielo***▲		120–200		•													
Fasio	∅5/9			•													
Gina*	3,5×3,5			•													
Grado	∅6/10			•													
Indus	6×2	140–200		•	•												
Jeno	12×5		•	•													
Jump*	∅10/12			•													
Mico	8×8		•	•													
Quada	20×6,5			•	•												
Rally	∅10			•													
Reca	24×12		•														
Road**	∅13			•													
Slid	8/1	140–200		•	•												
Soko	∅6			•	•												
Stomp	∅8		•	•	•	•											
Tondo	∅3,5			•													

\*bei Dallas 23 nur Einlegetiefe 23 cm möglich | pour Dallas 23 uniquement avec profondeur d'insertion 23 cm | with Dallas 23 only 23 cm insertion depth possible

\*\*Füsse fixiert, Rollen nur optisch | pieds fixes, roulettes uniquement décoration | feet fixed, castors only visual

\*\*\*Cielo nur mit Loft 18 und Dallas 23 Rahmen möglich | Cielo uniquement possible avec cadre de lit Loft 18 et Dallas 23 | Cielo only possible with frame Loft 18 and Dallas 23

▲Curty Vorhang und Vela Baldachin-Tuch siehe Register 2, Seite 12 | Curty rideau et Vela tissu de baldaquin voir registre 2, page 12 | Curty curtain and Vela canopy cloth see index 2, page 12



# Bettkasten mit Holzkufe | tiroir de lit avec patins en bois | bed drawer with wooden vat

## Lovie-Box + Covero - 1 FSC 90-140 cm 1 Schublade | 1 tiroir | 1 drawer

**Stauraum** | compartiment de rangement | storage space:  
134×61×16 cm

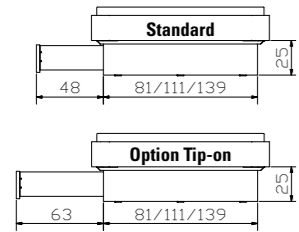

**Standard:** gedämpfter Selbststeinzug Blumotion von BLUM  
**Option:** Tip-on-Öffnung mit Vollauszug von BLUM

## Lovie-Box + Saceto - 1 FSC 140-200 cm 2 Schubladen | 2 tiroirs | 2 drawers

**Stauraum** | compartiment de rangement | storage space:  
2×134×61×16 cm

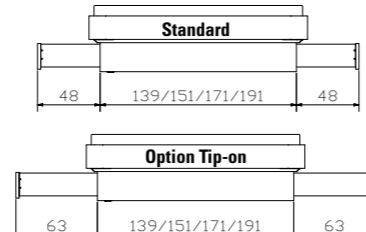

**standard:** système d'amortissement Blumotion de BLUM  
**option:** ouverture Tip-on avec sortie totale de BLUM  
**standard:** soft closing runner Blumotion of BLUM  
**option:** opening Tip-on with full extension of BLUM

## Roll-Box 20/25 FSC



**Voraussetzungen für Einsatz Bettkasten**  
**Generell**  
Bettfußhöhe von (mindestens) 20 oder 25 cm erforderlich.  
**Seitlich**  
mit Midtraver möglich.  
**Optionen**  
Deckel Covero in weiss, Stoffabdeckung Saceto in Polyester grau.

## Roll-Box 20/25 + Covero FSC



**Conditions d'utilisation d'un tiroir de lit**  
**En général**  
Une hauteur de pieds de lit d'au (moins) 20 cm ou 25 cm est nécessaire.  
**Insertion latérale**  
avec Midtraver possible.  
**Options**  
Couvercle Covero en blanc, tissu de protection Saceto en polyester gris.

## Roll-Box 20/25 + Saceto FSC



**Requirements for using bed drawer**  
**General**  
Feet of bed need a (minimum) height of 20 cm or 25 cm.  
**Laterally**  
with Midtraver possible.  
**Options**  
Covero in white, tissue of protection Saceto in polyester grey.



### Roll-Box 20



### Roll-Box 25



**Stauraum** | compartiment de rangement | storage space

Roll-Box 20	=	134×61×13 cm
Roll-Box 25	=	134×61×16 cm

# Bettkasten | coffre à literie | bedding box

## Practico-Box + Loft 18 + Ultrafree-Lift KF



### Ultrafree-Lift KF

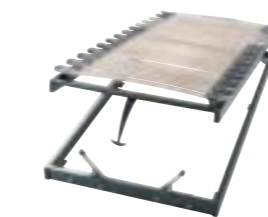

Box = inkl. Boden, Anwendung siehe Seite 5.17  
**zu Practico-Box:**  
Lattenrost **Ultrafree-Lift KF**  
Kopf-/Fussverstellung  
Rahmenholme Höhe 7 cm und 28 Federleisten aus Buchenschichtholz  
Gesamthöhe 11 cm

Lattenrost **Econom-move**  
Unverstellbar  
Rahmenholme Höhe 6 cm und 28 Federleisten aus Buchenschichtholz  
Gesamthöhe 9 cm

inkl. Gasdruckfedern und allen Beschlägen

**Details zu Ultrafree-Lift KF und Econom-move**  
siehe Register 13, Seite 6

## Practico-Box + Loft 18 + Econom-move



### Econom-move



box = fond inclus, utilisation voir page 5.17  
**pour box Practico:**  
Sommier **Ultrafree-Lift KF**  
Tête et pied réglables  
Cadre, hauteur 7 cm et 28 lattes en hêtre multiplis  
Hauteur totale 11 cm

Sommier **Econom-move**  
Non réglable  
Cadre, hauteur 6 cm et 28 lattes en hêtre multiplis  
Hauteur totale 9 cm

Pistons à gaz et toute la quincaillerie inclus

**Détails pour Ultrafree-Lift KF et Econom-move**  
voir registre 13, page 6

**Stauraum** | compartiment de rangement | storage space

90 × 200/210/220	=	81 × 190/200/210 × 24 cm
100 × 200/210/220	=	91 × 190/200/210 × 24 cm
120 × 200/210/220	=	111 × 190/200/210 × 24 cm
140 × 200/210/220	=	131 × 190/200/210 × 24 cm
160 × 200/210/220	=	74 × 190/200/210 × 24 (2 x) cm
180 × 200/210/220	=	84 × 190/200/210 × 24 (2 x) cm
200 × 200/210/220	=	94 × 190/200/210 × 24 (2 x) cm

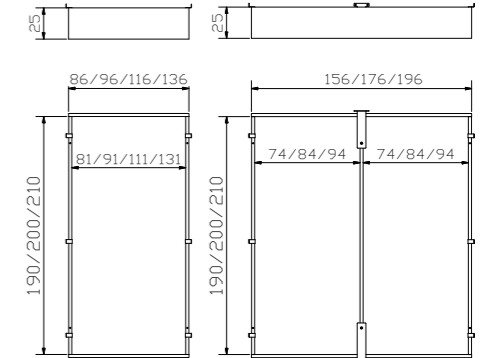

box = bottom incl., handling see page 5.17  
**for Practico-box:**  
Slats **Ultrafree-Lift KF**  
Head/footpiece adjustable  
Frame, height 7 cm and 28 slats are of beech veneer board  
Total height 11 cm

Slats **Econom-move**  
Not adjustable  
Frame, height 6 cm and 28 slats are of beech veneer board  
Total height 9 cm

Pneumatic compression spring and all fittings included

**Details for Ultrafree-Lift KF and Econom-move**  
see index 13, pages 6

# Himmelbett ohne Grenzen lit à baldachin sans frontières | canopy bed without borders

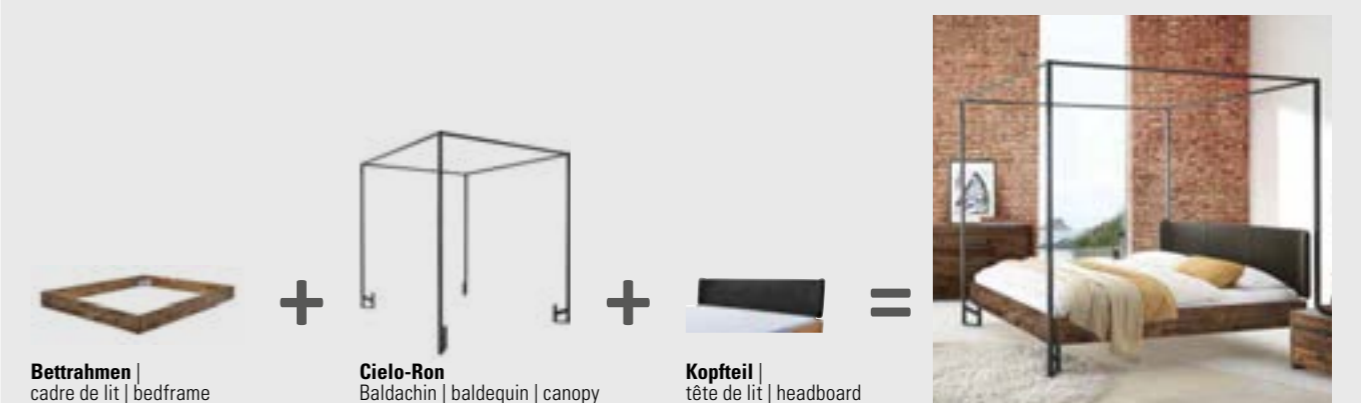

**Bettrahmen** | cadre de lit | bedframe

**Cielo-Ron** | Baldachin | baldaquin | canopy

**Kopfteil** | tête de lit | headboard

# Kopfteile | têtes de lit | headboards

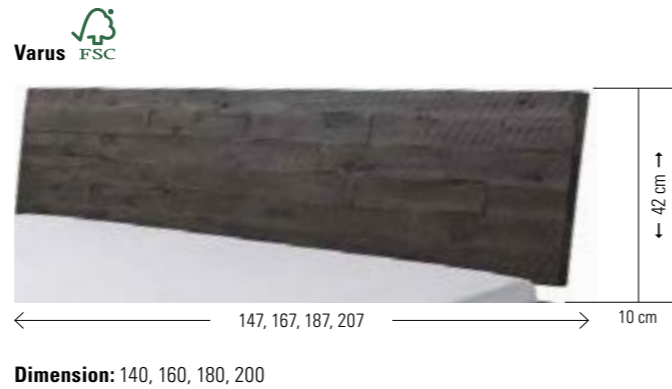

**Kopfteile in allen Holz-Ausführungen erhältlich siehe Seite 5.11**  
Têtes de lit disponibles dans toutes les versions bois voir page 5.11  
Headboards in all wooden executions available see page 5.11

**\*nur mit Bettrahmen Bloc 16 möglich**  
uniquement possible avec cadre de lit Bloc 16  
only possible with bed frame Bloc 16

**Gepolsterte Kopfteile, Wandpaneele, Stoffauswahl/Farben siehe Register 1, Lampen siehe Register 2.**  
Têtes de lits rembourrées, panneaux muraux, choix de tissus/couleurs voir registre 1, lampes voir registre 2.  
Upholstered headboards, wallpanels, choice of tissues/colours see index 1, lamps see index 2.

## Adapter | adaptateur | adapter

**Bei hohen Matratzen kann mit dem Verlängerungsadapter das Kopfteil erhöht werden.**  
La tête de lit peut être rehaussée avec l'adaptateur quand le matelas est plus épais.  
With the extension adapter the headboard can be extended if mattresses are high.

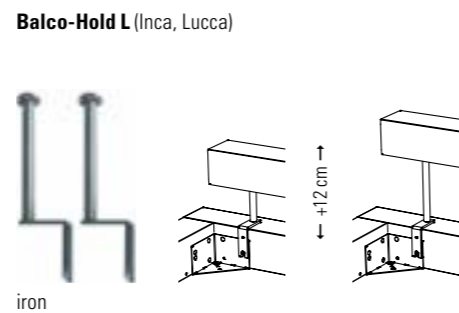
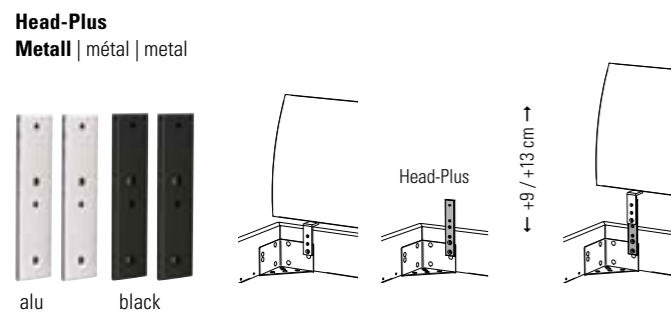

# Kissen zu Kopfteilen | coussins pour têtes de lit | cushions for headboards



**Befestigung mit 2 Bändern (Klettverschluss)**  
Fixation avec 2 bandes (Velcro®)  
Fixation with 2 ribbons (Velcro® fastener)



Kissen   coussins   cushions	Effektive Masse cm dimensions effectives cm effective dimensions cm	zu Kopfteilen pour têtes de lit for headboards				Breitenmasse cm dimensions de largeur cm widths dimensions cm
		Arcada	Varus	Inca	Xara	
Arona	86, 116, 136, 156, 176×3,5×25	●				90/100, 120, 140, 160, 180/200
Lumo	86, 116, 136, 156, 176×6×25	●				90/100, 120, 140, 160, 180/200
Nakio (2er Set   set de 2   set of 2)	55×19×14			●		
Ravo	80, 110, 130, 150, 170, 190×3,5×35	●	●		●	90/100, 120, 140, 160, 180, 200
Sunny (2er Set   set de 2   set of 2)	55×6×40	●	●			
Varo (2er Set   set de 2   set of 2)	55×10×35	●	●		●	

**Stoffauswahl/Farben für Kissen siehe Register 1, Seiten 6–7**  
Choix de tissus/couleurs pour coussins voir registre 1, pages 6–7  
Choice of tissues/colours for cushions see index 1, pages 6–7

## Ausführungen | exécutions | executions

### Holz | bois | wood

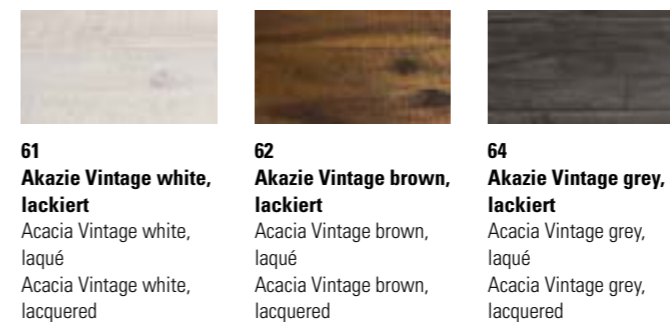

gepolstert | rembourrées | upholstered

Coria



Dimension: 120, 140, 160, 180, 200

Dorma\*



Dimension: 140, 160, 180, 200

\*nur mit Betrahmen Bloc möglich | uniquement possible avec cadre de lit Bloc | only possible with bed frame Bloc



**Gepolsterte Kopfteile, Wandpaneele, Stoffauswahl/Farben siehe Register 1, Lampen siehe Register 2.**

Têtes de lits rembourrées, panneaux muraux, choix de tissus/couleurs voir registre 1, lampes voir registre 2.

Upholstered headboards, wallpanels, choice of tissues/colours see index 1, lamps see index 2.

Opera\*



Dimension: 140, 160, 180, 200

## Nachttische, Kommoden | tables de nuit, commodes | bedside tables, chests of drawers

Lona FSC

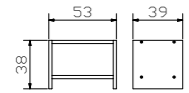

Carpi FSC

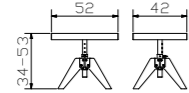

◀ **höhenverstellbar**  
réglable en hauteur  
adjustable in height

▶ **inkl. Glasplatte**  
plateau en verre inclus  
incl. glass plate

Butch

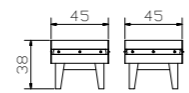

Rio FSC

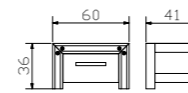

Cali FSC

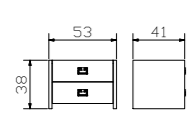

Tercio FSC

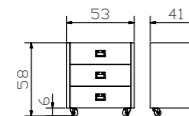

Rivera FSC

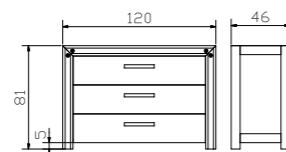

Case 4 (Option)



**4er Set zu** | set de 4 pour | set of 4 for:  
Lona, Cali, Tercio, Rio, Rivera, Banco, Scola

Bank + Kissen | banquette + coussin | bench + cushion

Banco FSC

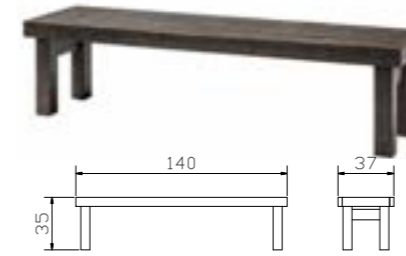

Vano



Topia

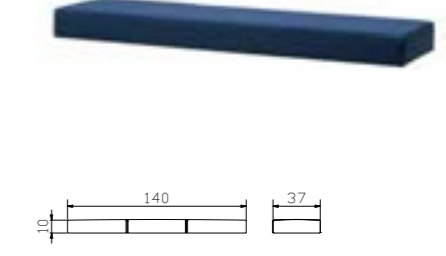

**Vano, Topia**  
**Bezugsstoffe siehe Register 1, Seiten 6 – 7**  
Tissus de revêtement voir registre 1, pages 6 – 7  
Cover fabrics see index 1, pages 6 – 7

Sekretär | secrétaire | bureau

höhenverstellbar | réglable en hauteur | adjustable in height

Scola / Case 4

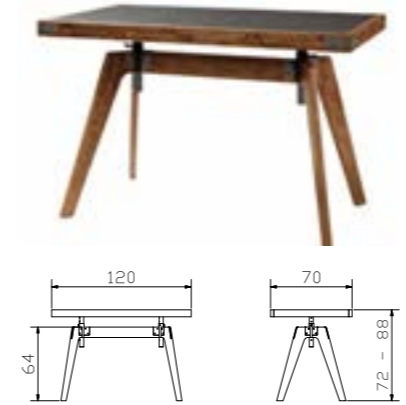

Ausführungen | exécutions | executions

Holz | bois | wood



**61 Akazie Vintage white, lackiert**  
Acacia Vintage white, laqué  
Acacia Vintage white, lacquered



**62 Akazie Vintage brown, lackiert**  
Acacia Vintage brown, laqué  
Acacia Vintage brown, lacquered



**64 Akazie Vintage grey, lackiert**  
Acacia Vintage grey, laqué  
Acacia Vintage grey, lacquered

# Nachttische, Kommoden | tables de nuit, commodes | bedside tables, chests of drawers

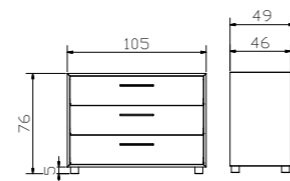
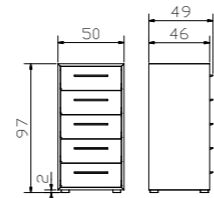
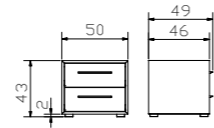

**Modo, Tola, Chest** standardmässig mit Griffen Rivo used, optional Covo und andere Farben. Korpus = MDF betonfarbig lackiert, Innenschubladen = Akazie massiv, grau lackiert; Fronten in allen aufgeführten Holz Ausführungen erhältlich | standard avec poignées Rivo used, en option poignées Covo et d'autres couleurs. Corps = mdf teinté beton, laqué; tiroirs intérieur = acacia massif, gris lacqué, façades dans tous les exécutions en bois mentionnés disponible | with handles Rivo used standard, optional Covo handles and other colours. Corpus = mdf concrete coloured, lacquered; inside drawers = solid acacia, grey lacquered, fronts in all listed wooden executions available

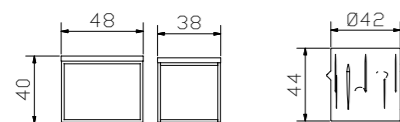

höhenverstellbar  
réglable en hauteur  
adjustable in height

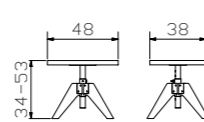

**Duqa, Pira = Auflageplatte Echtbeton** | plaque d'appui béton véritable | support plate real concrete  
**Tree = Echtbeton, Farb- und Strukturunterschiede sind naturbedingte Eigenschaften** | béton véritable, les différences de couleurs et structures sont des particularités naturelles. | real concrete, differences in colour and structures are natural characteristics.

# Zubehör | accessoires | accessories

## Ausführungen | exécutions | executions

### Holz | bois | wood

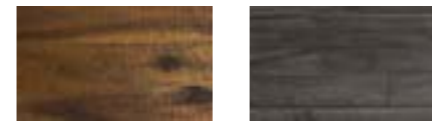

**62 Akazie Vintage brown, lackiert**  
Acacia Vintage brown, laqué  
Acacia Vintage brown, lacquered

**64 Akazie Vintage grey, lackiert**  
Acacia Vintage grey, laqué  
Acacia Vintage grey, lacquered

### Beton | béton | concrete



**20 Beton grey**  
béton grey  
concrete grey

### Atrio alu, anthracit + Tola



**Rückplatte + Boden in weiss oder anthracit**  
Plaque arrière + base en blanc ou anthracite  
Back panel + base in white or anthracite

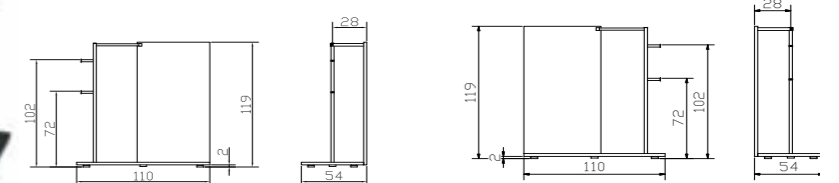

**Metallstange/Rückplatte links und rechts montierbar** | barre métallique/plaque arrière peut être montée à gauche et à droite | metal bar/back plate can be assembled left and right



**Option: Tray Holzablage für Atrio = Beton (MDF) lackiert**  
vide poche Tray pour Atrio = béton (mdf) laqué  
wooden shelf Tray for Atrio = concrete (mdf) lacquered

## Füsse | pieds | feet = Option zu | pour | for Modo, Tola, Chest

**Leg** alu, chrom, inox



**Piedo** alu, chrom



**Roll** alu, chrom



**Jone** anthracit, used



**Tindo** alu, anthracit, bronze, copper



**Fuss Set (4 Stk.)** | set de pieds (4 pcs) | set of feet (4 pcs)

## Griffe | poignées | handles

**Covo**  
= Modo, Tola, Chest



**Rivo**  
= Modo, Tola, Chest



## Metall | métal | metal



**00 Chrom**

**04 Used**

**10 White**

**16 Anthracit**

**40 Bronze**

**41 Copper**

**42 Alu**

**43 Inox**

**45 Iron**

**Chrom = Metall verchromt** | métal chromé | metal chrome

**Used = Metall galvanisiert** | métal galvanisé | metal galvanised

**White = Metall pulverbeschichtet** | métal thermolaqué | metal powder-coated

**Anthracit = Metall pulverbeschichtet** | métal thermolaqué | metal powder-coated

**Bronze = Metall lackiert** | métal laqué | metal lacquered

**Copper = Metall lackiert** | métal laqué | metal lacquered

**Alu = Metall pulverbeschichtet** | métal thermolaqué | metal powder-coated

**Inox = Edelstahl gebürstet** | acier inoxydable brossé | stainless steel brushed

**Iron = Metall geflammt, pulverbeschichtet** | métal flammé, thermolaqué | metal mottled, powder-coated

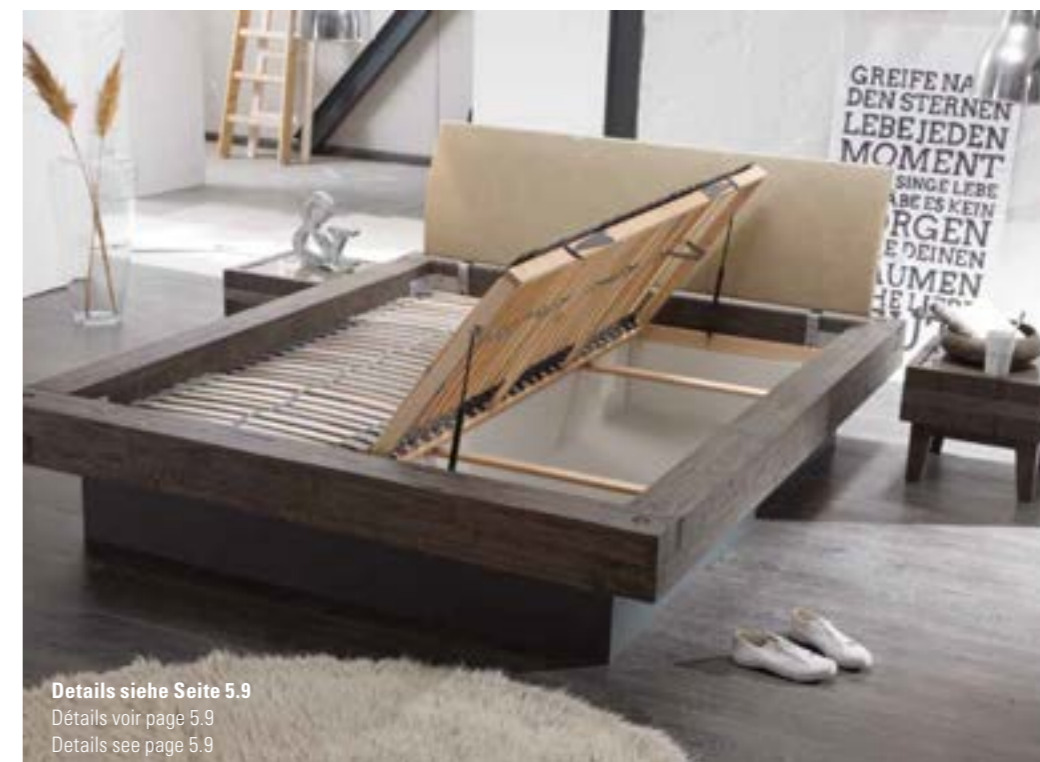

Details siehe Seite 5.9  
 Détails voir page 5.9  
 Details see page 5.9

				Dimension cm
<b>Rivera</b>	Kommode	commode	chest of drawers	120/46/81
<b>Butch</b>	Nachttisch	table de nuit	bedside table	45/45/38

				Dimension cm
<b>Bloc 16</b>	Rahmen Breiten Längen	cadre largeurs longueurs	frame widths lengths	140, 160, 180, 200 200, 210, 220
<b>Practico-Box</b>	Anthrazit Breiten Längen Höhe	anthracite largeurs longueurs hauteur	anthracite widths lengths height	140, 160, 180, 200 200, 210, 220 25
<b>Ripo</b>	Kopfteil, Casual sahara 330 siehe Register 1	tête de lit, Casual sahara 330 voir registre 1	headboard, Casual sahara 330 see index 1	90, 100, 120, 140, 160, 180, 200

Alle Holzteile in Akazie Vintage grey | toutes les parties en bois en acacia Vintage grey | all wooden parts in acacia Vintage grey  
 Weitere Beimöbel siehe Register 2 | autres accessoires voir registre 2 | further accessories see index 2

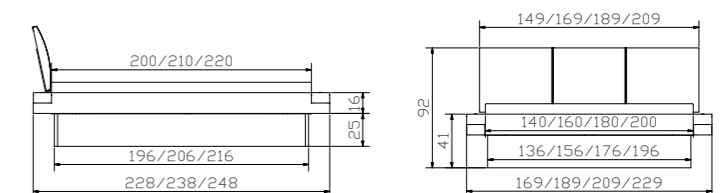



				Dimension cm
<b>Scola</b>	Sekretär	secrétaire	bureau	120/70/72-88
<b>Tree</b>	Nachttisch/Hocker	table de nuit/tabouret	bedside table/stool	Ø 42/44
<b>Pira</b>	Nachttisch höhenverstellbar 34–53 cm	table de nuit réglable en hauteur 34–53 cm	bedside table adjustable in height 34–53 cm	52/42/34-53



**Alle Holzteile in Akazie Vintage brown lackiert** | toutes les parties en bois en acacia Vintage brown laqué | all wooden parts in acacia Vintage brown lacquered

**Tree + Auflageplatte Pira Echtbeton** | corps Tree + plaque d'appui Pira béton véritable | Tree + support plate Pira real concrete

**Weitere Beimöbel siehe Register 2** | autres accessoires voir registre 2 | further accessories see index 2

				Dimension cm
<b>Bloc 16</b>	Rahmen Breiten Längen	cadre largeurs longueurs	frame widths lengths	140, 160, 180, 200 200, 210, 220
<b>Slid anthracit</b>	Kufen Breiten Höhe	patins largeurs hauteur	vats widths height	140, 160, 180, 200 20, 25
<b>Opera</b>	Kopfteil, Prisma silver 674	tête de lit, Prisma silver 674	headboard, Prisma silver 674	140, 160, 180, 200

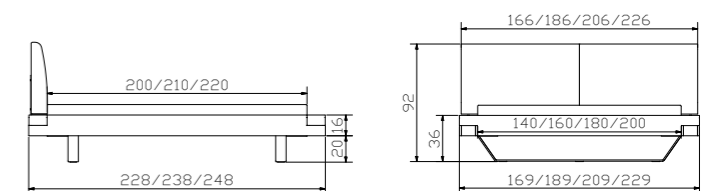



				Dimension cm
<b>Rivera</b>	Kommode	commode	chest of drawers	120/46/81
<b>Carpi</b>	Nachttisch höhenverstellbar 34–53 cm	table de nuit réglable en hauteur 34–53 cm	bedside table adjustable in height 34–53 cm	52/42/34-53



**Alle Holzteile in Akazie Vintage grey lackiert |**  
toutes les parties en bois en acacia Vintage grey  
laqué | all wooden parts in acacia Vintage grey  
lacquered

**Weitere Beimöbel siehe Register 2 |** autres acces-  
soires voir registre 2 | further accessories see index 2

				Dimension cm
<b>Bloc 16</b>	Rahmen Breiten Längen	cadre largeurs longueurs	frame widths lengths	140, 160, 180, 200 200, 210, 220
<b>Stabil</b>	Kufen Breiten Höhe	patins largeurs hauteur	vats widths height	140, 160, 180, 200 25
<b>Inca Nakio</b>	Kopfteil Kissen (2er Set) Casual carbon 334	tête de lit coussins (set de 2) Casual carbon 334	headboard cushions (set of 2) Casual carbon 334	140/160, 180/200 55/19/14

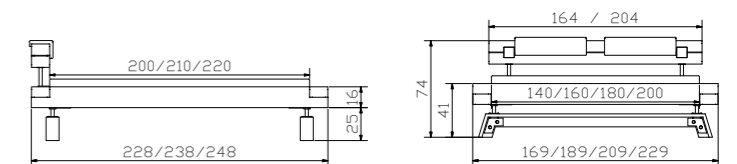



				Dimension cm
<b>Bloc 16</b>	Rahmen Breiten Längen	cadre largeurs longueurs	frame widths lengths	140, 160, 180, 200 200, 210, 220
<b>Festo</b>	Füße Höhen	pieds hauteurs	feet heights	20, 25
<b>Lucca</b>	Kopfteil	tête de lit	headboard	140/160, 180/200
<b>Cali</b>	Nachttisch	table de nuit	bedside table	53/41/38

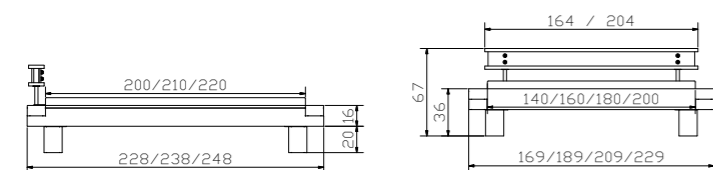

5.22

**Alle Holzteile in Akazie Vintage white lackiert** | toutes les parties en bois en acacia Vintage white laqué | all wooden parts in acacia Vintage white lacquered

**Weitere Beimöbel siehe Register 2** | autres accessoires voir registre 2 | further accessories see index 2

				Dimension cm
<b>Dorma</b>	Kopfteil, Kitana nougat 601	tête de lit, Kitana nougat 601	headboard, Kitana nougat 601	140, 160, 180, 200
<b>Inca</b> <b>Nakio</b>	Kopfteil Kissen (2er Set) Kitana nougat 601	tête de lit coussins (set de 2) Kitana nougat 601	headboard cushions (set of 2) Kitana nougat 601	140/160, 180/200 55/19/14

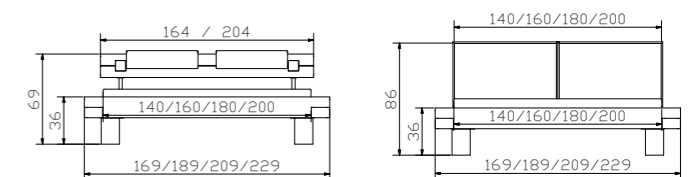

5.23



				Dimension cm
<b>Rivera</b>	Kommode	commode	chest of drawers	120/46/81
<b>Butch</b>	Nachttisch	table de nuit	bedside table	45/45/38

				Dimension cm
<b>Loft 18</b>	Rahmen	cadre	frame	
	Breiten	largeurs	widths	90, 100, 120, 140, 160, 180, 200
	Längen	longueurs	lengths	200, 210, 220
<b>Case 8 used</b>	Winkel (8er-Set)	équerres (set de 8)	brackets (set of 8)	
<b>Gola</b>	Füsse	pieds	feet	
	Höhen	hauteurs	heights	20, 25
<b>Varus</b>	Kopfteil	tête de lit	headboard	140, 160, 180, 200
<b>Ravo</b>	Kissen, Casual carbon 334	coussin, Casual carbon 334	cushion, Casual carbon 334	140, 160, 180, 200

Alle Holzteile in Akazie Vintage brown lackiert | toutes les parties en bois en acacia Vintage brown laqué | all wooden parts in acacia Vintage brown lacquered  
 Lampen und weitere Beimöbel siehe Register 2 | lampes et autres accessoires voir registre 2 | lamps and further accessories see index 2

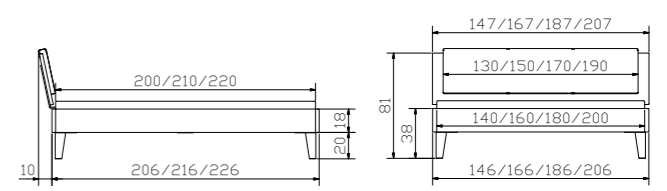



				Dimension cm
<b>Topa</b> bronze	Bank inkl. Kissen Prisma jade 672	banquette, coussin incl. Prisma jade 672	bench, cushion incl. Prisma jade 672	144/44/38
<b>Scola</b> <b>Case</b> used	Sekretär, höhenverstellbar Winkel (4er-Set)	secrétaire, réglable en hauteur équerres (set de 4)	bureau, adjustable in height brackets (set of 8)	120/70/72-88
<b>Tree</b>	Nachttisch/Hocker	table de nuit/tabouret	bedside table/stool	∅ 42/44
<b>Modo</b> <b>Rivo</b> bronze	Nachttisch Griffe (2er Set)	table de nuit poignées (set de 2)	bedside table handles (set of 2)	50/49/43
<b>Smart</b> black	Lampen (2er Set) 12V DC, 30 LED warm	Lampes (set de 2) 12V DC, 30 LED warm	Lamps (set of 2) 12V DC, 30 LED warm	

				Dimension cm
<b>Loft 18</b>	Rahmen Breiten Längen	cadre largeurs longueurs	frame widths lengths	90, 100, 120, 140, 160, 180, 200 200, 210, 220
<b>Fasio</b> bronze	Füße Höhe	pieds hauteur	feet height	20
<b>Boga</b>	Kopfteil, Prisma jade 672 siehe Register 1	tête de lit, Prisma jade 672 voir registre 1	headboard, Prisma jade 672 see index 1	90, 100, 120, 140, 160, 180, 200

**Alle Holzteile in Akazie Vintage grey lackiert** | toutes les parties en bois en acacia Vintage grey laqué | all wooden parts in acacia Vintage grey lacquered

**Tree in Echtbeton** | Tree en béton véritable | Tree in real concrete

**Lampen und weitere Beimöbel siehe Register 2** | lampes et autres accessoires voir registre 2 | lamps and further accessories see index 2

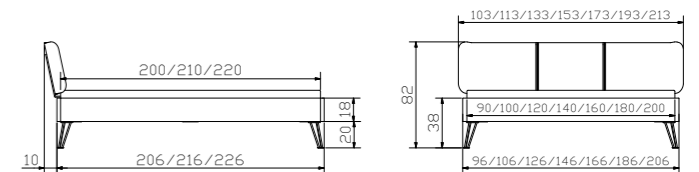



				Dimension cm
<b>Malta</b>	Kopfteil Alpina smoke 394 Alpina lightgrey 390 siehe Register 1	tête de lit Alpina smoke 394 Alpina lightgrey 390 voir registre 1	headboard Alpina smoke 394 Alpina lightgrey 390 see index 1	120, 140, 160, 180, 200
<b>Rivera</b>	Kommode	commode	chest of drawers	120/46/81
<b>Study</b>	Schreibtisch, weiss	bureau, blanc	desk, white	160/80/75

				Dimension cm
<b>Loft 18</b>	Rahmen Breiten Längen	cadre largeurs longueurs	frame widths lengths	90, 100, 120, 140, 160, 180, 200 200, 210, 220
<b>Case 8 used</b>	Winkel (8er-Set)	équerres (set de 8)	brackets (set of 8)	
<b>Ivio</b>	Füsse Höhen	pieds hauteurs	feet heights	10, 20, 25
<b>Malta</b>	Kopfteil, Kabo calc 630 siehe Register 1	tête de lit, Kabo calc 630 voir registre 1	headboard, Kabo calc 630 see index 1	120, 140, 160, 180, 200
<b>Tercio</b>	Nachttisch/Rollcontainer	table de nuit/caisson à roulettes	bedside table/rolling container	53/41/58
<b>Roll-Box</b>	Bettkasten, weiss Höhen	tiroir de lit, blanc hauteurs	bed drawer, white heights	137/67 19, 24
<b>Lona Case used</b>	Nachttisch Winkel (4er-Set)	table de nuit équerres (set de 4)	bedside table brackets (set of 4)	53/39/38

**Alle Holzteile in Akazie Vintage brown oder white lackiert** | toutes les parties en bois en acacia Vintage brown ou white laqué | all wooden parts in acacia Vintage brown or white lacquered

**Lampen und weitere Beimöbel siehe Register 2** | lampes et autres accessoires voir registre 2 | lamps and further accessories see index 2

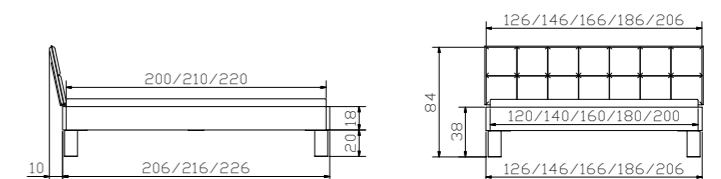



**Dimension cm**

<b>Scola</b>	Sekretär	secrétaire	bureau	120/70/72-88
<b>Banco</b>	Bank	banquette	bench	140/37/35
<b>Rivera</b>	Kommode	commode	chest of drawers	120/46/81
<b>Cali</b>	Nachttisch	table de nuit	bedside table	53/41/38
<b>Curty</b>	Baldachin-Vorhang (3er Set) Baumwolle weiss	rideau de baldachin (set de 3) coton blanc	curtain of canopy (set of 3) cotton white	272/185 (3x)

**Dimension cm**

<b>Loft 18</b>	Rahmen Breiten Längen	cadre largeurs longueurs	frame widths lengths	90, 100, 120, 140, 160, 180, 200 200, 210, 220
<b>Cielo anthracit</b>	Baldachin Breiten Längen Höhe, Boden bis Unterkante Bettrahmen	baldachin largeurs longueurs hauteur, Du sol au bord inférieur du cadre du lit	canopy widths lengths height, Floor to lower edge of bed frame	120, 140, 160, 180, 200 200, 210, 220 20
<b>Obag</b>	Kopfteil, Casual carbon 334 siehe Register 1	tête de lit, Casual carbon 334 voir registre 1	headboard, Casual carbon 334 see index 1	140, 160, 180, 200



**Curty**

**Alle Holzteile in Akazie Vintage brown lackiert** | toutes les parties en bois en acacia Vintage brown laqué | all wooden parts in acacia Vintage brown lacquered

**Lampen und weitere Beimöbel siehe Register 2** | lampes at autres accessoires voir registre 2 | lamps and further accessories see index 2

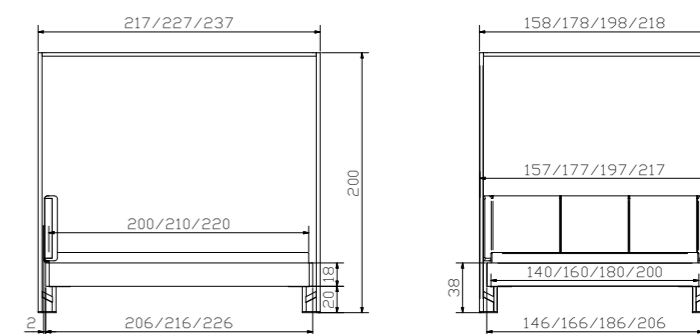



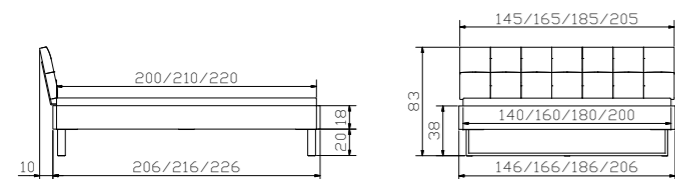

				Dimension cm
<b>Loft 18</b>	Rahmen Breiten Längen	cadre largeurs longueurs	frame widths lengths	90, 100, 120, 140, 160, 180, 200 200, 210, 220
<b>Indus iron</b>	Kufen Breiten Höhen	patins largeurs hauteurs	vats widths heights	140, 160, 180, 200 20, 25
<b>Ronna</b>	Kopfteil, Casual olive 333 siehe Register 1	tête de lit, Casual olive 333 voir registre 1	headboard, Casual olive 333 see index 1	90/100, 120, 140, 160, 180, 200
<b>Tina chrom</b>	Lampen (2er Set) 12 V DC, 1 LED	lampes (set de 2) 12 V DC, 1 LED	lamps (set of 2) 12 V DC, 1 LED	
<b>Cali</b>	Nachttisch	table de nuit	bedside table	53/41/38



**Alle Holzteile in Akazie Vintage brown lackiert** | toutes les parties en bois en acacia Vintage brown laqué | all wooden parts in acacia Vintage brown lacquered

**Lampen und weitere Beimöbel siehe Register 2** | lampes at autres accessoires voir registre 2 | lamps and further accessories see index 2

				Dimension cm
<b>Arcada Arona</b>	Kopfteil Kissen, Alpina lightgrey 390	tête de lit coussin, Alpina lightgrey 390	headboard cushion, Alpina lightgrey 390	90/100, 120, 140, 160, 180, 200 90/100, 120, 140, 160, 180/200
<b>Smart black</b>	Lampen (2er Set), schwarz 12V DC, 30 LED warm Dreistufenschaltung	lampes (set de 2), noir 12V DC, 30 LED warm interrupteur à 3 crans	lamps (set of 2), black 12V DC, 30 LED warm three step circuit	
<b>Varus Varo</b>	Kopfteil Kissen 2er Set, Kitana beige 600	tête de lit set de 2 coussins, Kitana beige 600	headboard set of 2 cushions, Kitana beige 600	140, 160, 180, 200 55/10/35
<b>Boa chrom</b>	Lampen (2er Set) 12V DC, 12 LED kalt weiss	lampes (set de 2) 12V DC, 12 LED blanc froid	lamps (set of 2) 12V DC, 12 LED cold white	

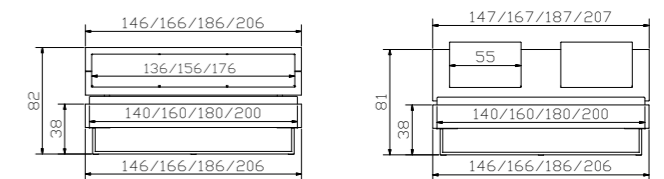



				Dimension cm
<b>Study</b> anthracit	Schreibtisch	bureau	desk	160/80/75
<b>Tercio</b>	Nachttisch/Rollcontainer	table de nuit/caisson à roulettes	bedside table/rolling container	53/41/58
<b>Cali</b>	Nachttisch	table de nuit	bedside table	53/41/38

				Dimension cm
<b>Loft 18</b>	Rahmen Breiten Längen	cadre largeurs longueurs	frame widths lengths	90, 100, 120, 140, 160, 180, 200 200 (220)
<b>Road used</b>	Füße fixiert Rollen nur optisch Höhe	pieds fixes roulettes uniquement décoration hauteur	feet fixed castors only visual height	20
<b>Ceneri</b>	Kopfteil, Casual carbon 334  hat Einfluss auf Bettlänge siehe Register 1 Seite 4	tête de lit, Casual carbon 334  a un impact sur la longueur du lit voir registre 1 page 4	headboard, Casual carbon 334  affects the length of bed see index 1 page 4	140, 160, 180, 200

Alle Holzteile in Akazie Vintage grey lackiert | toutes les parties en bois en acacia Vintage grey laqué | all wooden parts in acacia Vintage grey lacquered  
Lampen und weitere Beimöbel siehe Register 2 | lampes et autres accessoires voir registre 2 | lamps and further accessories see index 2

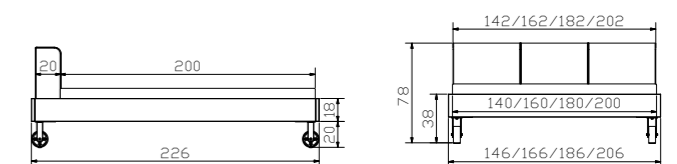



**Dimension cm**

<b>Rio</b>	Nachttisch	table de nuit	bedside table	60/41/36
<b>Roll-Box 20</b>	Bettkasten, weiss	tiroir de lit, blanc	bed drawer, white	137/67/19
<b>Study white</b>	Schreibtisch	bureau	desk	160/80/75
<b>Tercio</b>	Nachttisch/Rollcontainer	table de nuit/caisson à roulettes	bedside table/rolling container	53/41/58
<b>Rivera</b>	Kommode	commode	chest of drawers	120/46/81
<b>Snake alu</b>	Lampen (2er Set) 12V DC, 6 LED 3 Beleuchtungsarten	lampes (set de 2) 12V DC, 6 LED 3 différent illuminations	lamps (set of 2) 12V DC, 6 LED 3 different illuminations	

**Dimension cm**

<b>Loft 18</b>	Rahmen Breiten Längen Winkel (8er-Set)	cadre largeurs longueurs équerres (set de 8)	frame widths lengths brackets (set of 8)	90, 100, 120, 140, 160, 180, 200 200, 210, 220
<b>Ivivo</b>	Füsse Höhen	pieds hauteurs	feet heights	10, 20, 25
<b>Arcada Arona</b>	Kopfteil Kissen Campos blanc 372	tête de lit coussin Campos blanc 372	headboard cushion Campos blanc 372	90/100, 120, 140, 160, 180, 200 90/100, 120, 140, 160, 180/200

Alle Holzteile in Akazie Vintage grey oder weiss | toutes les parties en bois en acacia Vintage grey ou blanc | all wooden parts in acacia Vintage grey or white  
Lampen und weitere Beimöbel siehe Register 2 | lampes et autres accessoires voir registre 2 | lamps and further accessories see index 2

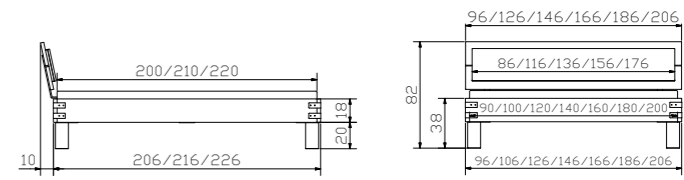



**Dimension cm**

<b>Study</b> anthracit	Schreibtisch	bureau	desk	160/80/75
<b>Tercio</b>	Nachttisch/Rollcontainer	table de nuit/caisson à roulettes	bedside table/rolling container	53/41/58
<b>Rivera</b>	Kommode	commode	chest of drawers	120/46/81
<b>Carpi</b>	Nachttisch höhenverstellbar 34–53 cm	table de nuit réglable en hauteur 34–53 cm	bedside table adjustable in height 34–53 cm	52/42/34-53
<b>Tina</b> chrom	Lampen (2er Set) 12 V DC, 1 LED	lampes (set de 2) 12 V DC, 1 LED	lamps (set of 2) 12 V DC, 1 LED	

**Dimension cm**

<b>Loft 18</b>	Rahmen Breiten Längen	cadre largeurs longueurs	frame widths lengths	90, 100, 120, 140, 160, 180, 200 200, 210, 220
<b>Lovie-Box</b>	1 Bettkasten Breiten 2 Bettkästen Breiten Höhe	1 tiroir de lit largeurs 2 tiroirs de lit largeurs hauteur	1 bed drawer widths 2 bed drawers widths height	90, 100, 120, 140 140, 160, 180, 200 25
<b>Ronna</b>	Kopfteil, Ranch jeans 662 siehe Register 1	tête de lit, Ranch jeans 662 voir registre 1	headboard, Ranch jeans 662 see index 1	90/100, 120, 140, 160, 180, 200

**Alle Holzteile in Akazie Vintage brown lackiert oder anthracit** | toutes les parties en bois en acacia Vintage brown laqué ou en anthracit | all wooden parts in acacia Vintage brown lacquered or anthracit

**Lampen und weitere Beimöbel siehe Register 2** | lampes et autres accessoires voir registre 2 | lamps and further accessories see index 2

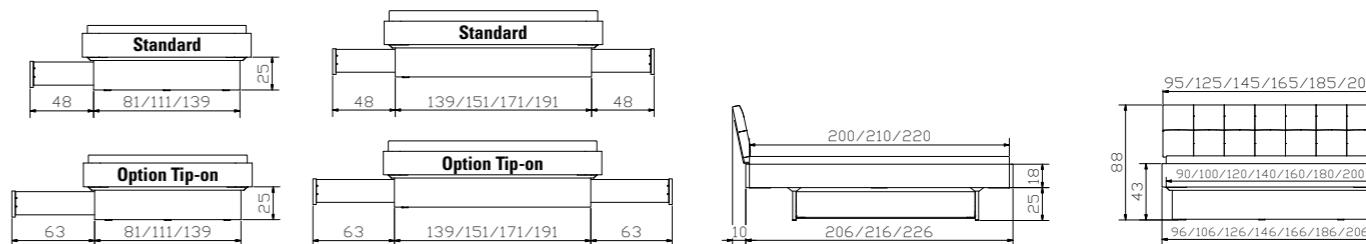



				Dimension cm
<b>Study</b>	Schreibtisch	bureau	desk	160/80/75
<b>Tercio</b>	Nachttisch/Rollcontainer	table de nuit/caisson à roulettes	bedside table/rolling container	53/41/58
<b>Cali</b>	Nachttisch	table de nuit	bedside table	53/41/38
<b>Lovie-Box</b>	1 Bettkasten	1 tiroir de lit	1 bed drawer	
	Breiten	largeurs	widths	140
	2 Bettkästen	2 tiroirs de lit	2 bed drawers	
	Breiten	largeurs	widths	140, 160, 180, 200
	Höhe	hauteur	height	25

				Dimension cm
<b>Dallas 23</b>	Rahmen	cadre	frame	
	Breiten	largeurs	widths	140, 160, 180, 200
	Längen	longueurs	lengths	200, 210, 220
<b>Gola</b>	Füße	pieds	feet	
	Höhen	hauteurs	heights	20, 25
<b>Coria</b>	Kopfteil, Kitana grigio 602	tête de lit, Kitana grigio 602	headboard, Kitana grigio 602	120, 140, 160, 180, 200

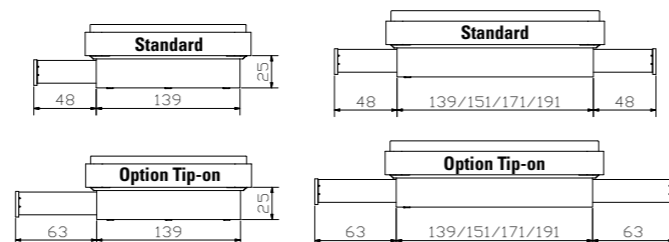

**Alle Holzteile in Akazie Vintage white oder weiss** | toutes les parties en bois en acacia Vintage white ou blanc | all wooden parts in acacia Vintage white or white  
**Lampen und weitere Beilmöbel siehe Register 2** | lampes et autres accessoires voir registre 2 | lamps and further accessories see index 2

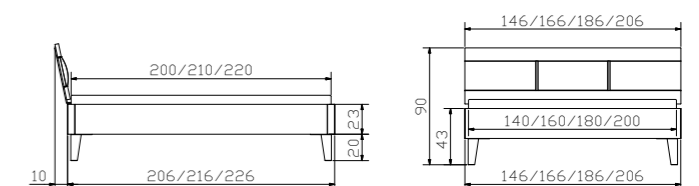



**Dimension cm**

<b>Tercio</b>	Nachttisch/Rollcontainer	table de nuit/caisson à roulettes	bedside table/rolling container	53/41/58
---------------	--------------------------	-----------------------------------	---------------------------------	----------

**Dimension cm**

<b>Dallas 23</b>	Rahmen Breiten Längen	cadre largeurs longueurs	frame widths lengths	140, 160, 180, 200 200, 210, 220
<b>Festo</b>	Füße Höhen	pieds hauteurs	feet heights	20, 25
<b>Umbia L</b>	Wandpaneel, Shine curry 684 nur für Wandmontage siehe Register 1, Seite 5	panneau mural, Shine curry 684 uniquement pour montage mural voir registre 1, page 5	wallpanel, Shine curry 684 wall assembly only see index 1, page 5	153, 173, 193, 213

Alle Holzteile in Akazie Vintage grey lackiert | toutes les parties en bois en acacia Vintage grey laqué | all wooden parts in acacia Vintage grey lacquered  
 Weitere Beimöbel siehe Register 2 | autres accessoires voir registre 2 | further accessories see index 2

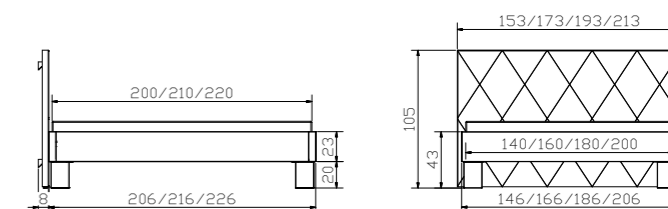



				Dimension cm
<b>Rivera</b>	Kommode	commode	chest of drawers	120/46/81
<b>Rivo anthracit</b>	Griffe (3er Set)	poignées (set de 3)	handles (set of 3)	
<b>Lona</b>	Nachttisch	table de nuit	bedside table	53/39/38

				Dimension cm
<b>Dallas 23</b>	Rahmen Breiten Längen	cadre largeurs longueurs	frame widths lengths	140, 160, 180, 200 200, 210, 220
<b>Slid anthracit</b>	Kufen Breiten Höhen	patins largeurs hauteurs	vats widths heights	140, 160, 180, 200 20, 25
<b>Xara</b>	Kopfteil	tête de lit	headboard	140, 160, 180, 200

**Alle Holzteile in Akazie Vintage brown** | toutes les parties en bois en acacia Vintage brown | all wooden parts in acacia Vintage brown  
**Weitere Beimöbel siehe Register 2** | autres accessoires voir registre 2 | further accessories see index 2

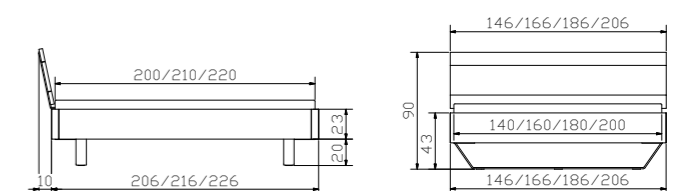



**Dimension cm**

<b>Banco</b>	Bank	banquette	bench	140/37/35
<b>Vano</b>	Kissen, Vintage marone 521	coussin, Vintage marone 521	cushion, Vintage marone 521	136/34/3
<b>Tola</b>	Kommode	commode	chest of drawers	50/49/97
<b>Duqa anthracit</b>	Nachttisch	table de nuit	bedside table	48/38/40

**Dimension cm**

<b>Dallas 23</b>	Rahmen Breiten Längen	cadre largeurs longueurs	frame widths lengths	140, 160, 180, 200 200 (210), 210 (220)
<b>Tondo anthracit</b>	Füße Höhe	pieds hauteur	feet height	20
<b>Cena</b>	Kopfteil, Vintage marone 521 hat Einfluss auf Bettlänge siehe Register 1 Seite 4	tête de lit, Vintage marone 521 a un impact sur la longueur du lit voir registre 1 page 4	headboard, Vintage marone 521 affects the length of bed see index 1 page 4	90, 100, 120, 140, 160, 180, 200

**Alle Holzteile in Akazie Vintage brown lackiert** | toutes les parties en bois en acacia Vintage brown laqué | all wooden parts in acacia Vintage brown lacquered  
**Korpus Tola MDF betonfarbig lackiert** | corps Tola en mdf teinté béton | corpus Tola in mdf concrete coloured, lacquered  
**Auflageplatte Duqa Echtbeton** | plaque d'appui Duqa béton véritable | support plate Duqa real concrete  
**Lampen und weitere Beimöbel siehe Register 2** | lampes et autres accessoires voir registre 2 | lamps and further accessories see index 2

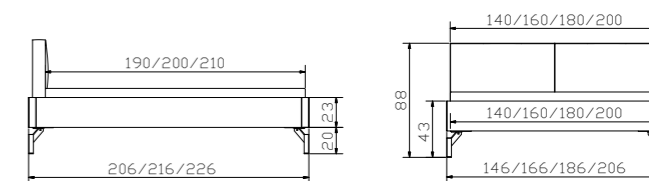



	Dimension cm		
<b>Lovie-Box</b>	1 Bettkasten	1 tiroir de lit	1 bed drawer
Breiten	largeurs	widths	140
2 Bettkästen	2 tiroirs de lit	2 bed drawers	140, 160, 180, 200
Breiten	largeurs	widths	25
Höhe	hauteur	height	

	Dimension cm		
<b>Dallas 23</b>	Rahmen	cadre	frame
Breiten	largeurs	widths	140, 160, 180, 200
Längen	longueurs	lengths	200, 210, 220
<b>Jeno used</b>	Füße	pieds	feet
Höhen	hauteurs	heights	10, 20, 25
<b>Coria</b>	Kopfteil, Casual carbon 334	tête de lit, Casual carbon 334	headboard, Casual carbon 334
			120, 140, 160, 180, 200
<b>Chest</b>	Kommode	commode	chest of drawers
			105/49/76
<b>Modo</b>	Nachttisch	table de nuit	bedside table
			50/49/43

**Ausführung Buche anthracit deckend lackiert** | Hêtre finition anthracite couvrant laqué | Beech anthracite covered lacquered

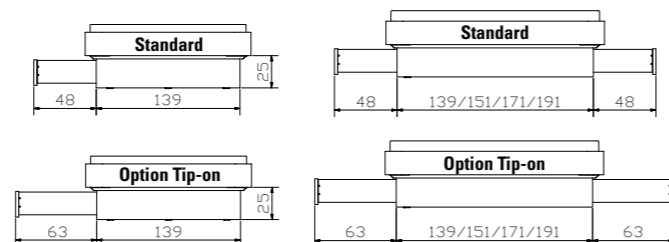

**Alle Holzteile in Akazie Vintage brown lackiert** | toutes les parties en bois en acacia Vintage brown laqué | all wooden parts in acacia Vintage brown lacquered

**Korpus Chest und Modo MDF betonfarbig lackiert** | corps Chest et Modo en mdf teinté béton | corps Chest and Modo in mdf concrete coloured, lacquered

**Lampen und weitere Beimöbel siehe Register 2** | lampes et autres accessoires voir registre 2 | lamps and further accessories see index 2

