



swiss bed concept



# MODERNO

**massiv** | massif | solid

Achten Sie auf FSC®-zertifizierte Produkte | soyez attentifs aux produits certifiés FSC® | look for FSC®-certified products



The mark of responsible forestry

#### Einfach zur Ruhe kommen

Mit unseren Moderno-Modellen gelingt dies auf schlichte, stilvolle Weise. Die in der Höhe oder im Profil auffälligen Bettrahmen und die besonders feine Verarbeitung von Massivholz sorgen für Finesse und Leichtigkeit im Schlafzimmer.

Unsere Moderno-Betten sind in den folgenden Ausführungen erhältlich:

- Kernbuche stabverleimt massiv, natur geölt
- Nussbaum natur, stabverleimt, geölt
- Buche, weiss deckend, lackiert
- Eiche bianco, stabverleimt, geölt

#### Eiche bianco, stabverleimt, geölt

Die Bezeichnung «Eiche Bianco» steht für eine Auswahl von besonders hellfarbigem und gleichmässigem Holz feinjähriger Weisseichen. Der ursprünglich markante Charakter der Eiche tritt bei dieser Auswahl in den Hintergrund. Möbel in dieser Ausführung wirken leicht und elegant.

#### Calme-toi, c'est tout

Avec nos modèles Moderno, cela réussit d'une manière simple et élégante. Les cadres de lit qui frappent par leur hauteur ou leur profil et la finition particulièrement soignée du bois massif garantissent finesse et légèreté dans la chambre à coucher.

Nos lits Moderno sont disponibles dans les versions suivantes :

- hêtre cœur rouge naturel, lamellé collé, huilé
- noyer naturel, lamellé collé, huilé
- hêtre, laqué blanc couvrant
- chêne bianco, lamellé collé, huilé

#### Chêne bianco, lamellé collé, huilé

La désignation «chêne bianco» est synonyme d'une sélection de bois particulièrement régulier et de couleur claire du chêne blanc à cernes fins. Dans cette sélection, le caractère du chêne, marquant à l'origine, passe en arrière-plan. Les meubles de cette variante dégagent une impression de légèreté et d'élégance.

#### Just come to rest

With our Moderno models this succeeds in a simple, stylish way. The bed frames that are striking in height or profile and the particularly fine workmanship of solid wood ensure finesse and lightness in the bedroom.

Our Moderno beds are available in the following versions:

- heart beech natural, glued-laminated, oiled
- walnut natural, glued-laminated, oiled
- beech, white covered lacquered
- oak bianco, glued-laminated, oiled

#### Oak bianco, glued-laminated, oiled

The designation «oak bianco» stands for a selection of particularly light-coloured and balanced wood of finely grained white oaks. The initially pronounced character of the oak fades into the background of this selection. Furniture with this wood variety appears light and elegant.

# Bettrahmen | cadre de lit | bedframe

## Piato 18



**Breiten** | largeurs | widths: 160, 180, 200 cm  
**Längen** | longueurs | lengths: 200, 210, 220 cm  
**Einlegetiefe** | hauteur encastrable | insertion depth: 18 cm

## Trento 23



**Breiten** | largeurs | widths: 140, 160, 180, 200 cm  
**Längen** | longueurs | lengths: 200, 210, 220 cm  
**Einlegetiefe** | hauteur encastrable | insertion depth: 18\*, 23 cm

### \* Trento 23

Bei der Einlegetiefe 18 cm sind die Füße/Sockel um 5 cm versenkt und um diese Höhe weniger sichtbar.

Avec la hauteur de cadre 18 cm les pieds/sockle sont encastrés de 5 cm sous le cadre et donc moins visibles.  
With the insertion depth 18 cm the feet/socket are sunken in by 5 cm and this height less visible.

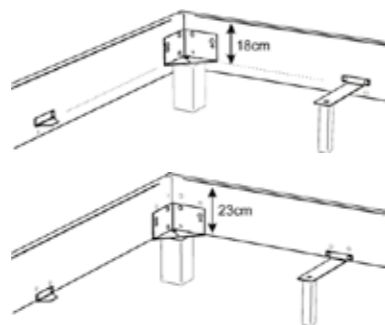

### Option Midtraver-move

nicht bei Füßen in der Höhe 30 cm anwendbar  
ne s'applique pas aux pieds à une hauteur de 30 cm  
not applicable for feet at a height of 30 cm

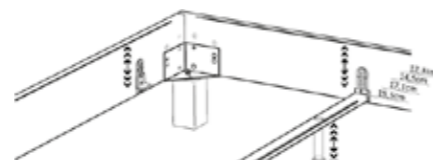

## Ausführungen | exécutions | executions

### Holz | bois | wood



**10 Buche weiss deckend, lackiert**  
Hêtre blanc couvrant, laqué  
Beech white covered, lacquered

**71 Eiche bianco, geölt**  
Chêne bianco, huilé  
Oak bianco, oiled

**80 Kernbuche natur, geölt**  
Hêtre cœur rouge naturel, huilé  
Heart beech natural, oiled

**85 Nussbaum, geölt**  
Noyer, huilé  
Walnut, oiled

# Traversen | traverses | bars

Wir empfehlen beim Einsatz von preisgünstigen Lattenrosten oder hoher Gewichtsbelastung eine **Crosstraver** (Quertraverse) oder **Crosstraver-Twin** (Quertraversen) beim Einsatz von Box/Conti. Für Betten ab 160 cm mit 2 Lattenrosten oder für den Motorrahmeneinbau eine **Midtraver** (Längstraverse).  
Midtraver und Crosstraver-Twin sind mit den Füßen Vilo nicht einsetzbar.

En cas d'intégration d'un sommier premier prix ou de charge importante nous recommandons une **Crosstraver** (traverse transversale) ou **Crosstraver-Twin** (traverses transversales) avec Box/Conti. Pour un cadre de lit à partir de 160 cm avec 2 sommiers ou pour l'encastrement d'un sommier à moteur une **Midtraver** (traverse centrale). Midtraver et Crosstraver-Twin non compatibles avec les pieds Vilo.

We recommend a **Crosstraver** (central cross bar) for use with budgetpriced slats or high weight loads or **Crosstraver-Twin** (cross bars) with Box/Conti. For beds wider than 160 cm with 2 slats or motorframes, a **Midtraver** (central bar). Midtraver and Crosstraver-Twin are not suitable with feet Vilo.

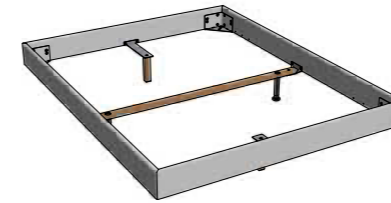

**Crosstraver**  
Quertraverse  
Traverse transversale  
Central cross bar

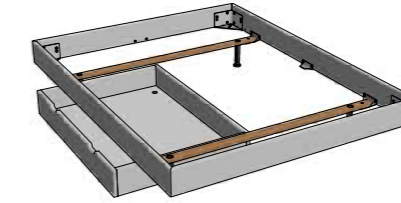

**Crosstraver-Twin**  
Quertraversen  
Traverses transversales  
Cross bars

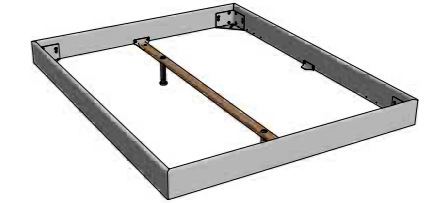

**Midtraver**  
Längstraverse  
Traverse centrale  
Central bar

# Bettkasten | coffre à literie | bedding box

## Practico-Box + Trento 23 + Ultrafree-Lift KF



Ultrafree-Lift KF



## Practico-Box + Trento 23 + Econom-move



Econom-move



### Stauraum | compartiment de rangement | storage space

140 × 200/210/220	=	131 × 190/200/210 × 24 cm
160 × 200/210/220	=	74 × 190/200/210 × 24 (2 x) cm
180 × 200/210/220	=	84 × 190/200/210 × 24 (2 x) cm
200 × 200/210/220	=	94 × 190/200/210 × 24 (2 x) cm

### Details zu Ultrafree-Lift KF und Econom-move siehe Register 14, Seite 6

Détails pour Ultrafree-Lift KF et Econom-move voir index 14, page 6  
Details for Ultrafree-Lift KF and Econom-move see index 14, pages 6

Box = inkl. Boden, Anwendung siehe Seiten 8.14 - 8.15

**zu Practico-Box:**  
Lattenrost **Ultrafree-Lift KF**  
Kopf-Fußverstellung  
Rahmenholme Höhe 7 cm und 28 Federleisten aus Buchenschichtholz  
Gesamthöhe 11 cm

Lattenrost **Econom-move**  
Unverstellbar  
Rahmenholme Höhe 6 cm und 28 Federleisten aus Buchenschichtholz  
Gesamthöhe 9 cm  
inkl. Gasdruckfedern und allen Beschlägen

box = fond inclus, utilisation voir pages 8.14 - 8.15

**pour box Practico:**  
Sommier **Ultrafree-Lift KF**  
Tête et pied réglables  
Cadre, hauteur 7 cm et 28 lattes en hêtre multiplis  
Hauteur totale 11 cm

Sommier **Econom-move**  
Non réglable  
Cadre, hauteur 6 cm et 28 lattes en hêtre multiplis  
Hauteur totale 9 cm  
Pistons à gaz et toute la quincaillerie inclus

box = bottom incl., handling see pages 8.14 - 8.15

**for Practico box:**  
Slats **Ultrafree-Lift KF**  
Head/footpiece adjustable  
Frame, height 7 cm and 28 slats are of beech veneer board  
Total height 11 cm

Slats **Econom-move**  
Not adjustable  
Frame, height 6 cm and 28 slats are of beech veneer board  
Total height 9 cm  
Pneumatic compression spring and all fittings included

# Füsse | pieds | feet

## Holz | bois | wood



Holz   bois   wood	Masse cm dim. cm	Breiten cm largeurs cm widths cm	Höhen cm hauteurs cm heights cm				Holzfarben couleurs bois colours wood							
			10	20	25	30	10	16	71	80	85			
Cantu	8x8			●	●	●	●		●	●	●	●		
Ivio	10x10		●	●	●	●	●		●	●	●	●		
Masi	6 x 4		●	●	●	●	●		●	●	●	●		
Practico-Box* (inkl. Boden   fond inclus   bottom included)		140–200			●		●	●	●					
Vilo		140–200	●	●			●	●	●	●	●	●		

\*weiss/anthrazit = MDF  
\*blanc/anthracite = MDF  
\*white/anthracite = MDF

## Ausführungen | exécutions | executions

### Holz | bois | wood

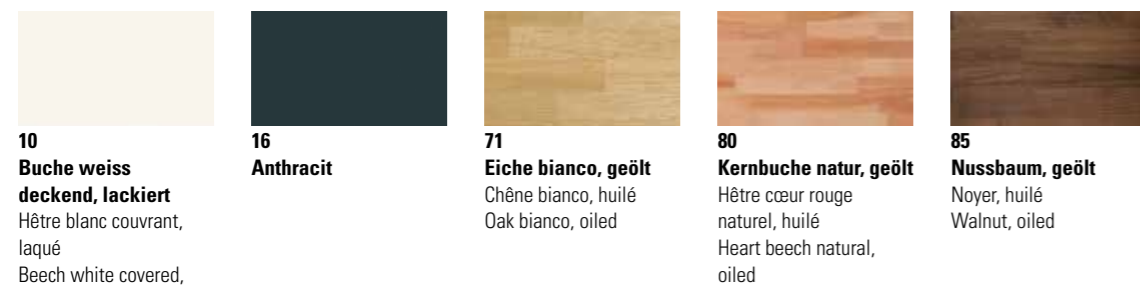

**10** Buche weiss deckend, lackiert  
Hêtre blanc couvrant, laqué  
Beech white covered, lacquered

**16** Anthracit

**71** Eiche bianco, geölt  
Chêne bianco, huilé  
Oak bianco, oiled

**80** Kernbuche natur, geölt  
Hêtre cœur rouge naturel, huilé  
Heart beech natural, oiled

**85** Nussbaum, geölt  
Noyer, huilé  
Walnut, oiled

# Füsse | pieds | feet

## Metall | métal | metal



Metall   métal   metal	Masse cm dim. cm	Breiten cm largeurs cm widths cm	Höhen cm hauteurs cm heights cm				Metallfarben couleurs métal colours metal								
			10	20	25	30	00	04	10	16	40	41	42	43	45
Caro	6x6		●	●	●		●			●		●			
Fasio	∅5/9		●	●					●	●	●				
Grado	∅6/10			●			●								
Indus	6x2	140–200		●	●				●				●	●	
Jeno	12x5		●	●	●			●	●	●					
Jump	∅10/12			●											
Mico	8x8		●	●	●	●			●			●	●	●	
Quada	20x6,5			●	●				●			●	●	●	
Reca	24x12		●										●	●	
Road**	∅13			●					●						
Slid	8/1	140 - 200		●	●					●			●		
Soko	∅6			●	●				●				●		
Stomp	∅8		●	●	●	●			●				●		
Tondo*	∅3,5			●						●	●	●	●		

\*nur mit Bettrahmen Piato 18 möglich | uniquement possible avec cadre de lit Piato 18 | only possible with bedframe Piato 18  
\*\*Füsse fixiert, Rollen nur optisch | pieds fixes, roulettes uniquement décoration | feet fixed, castors only visual

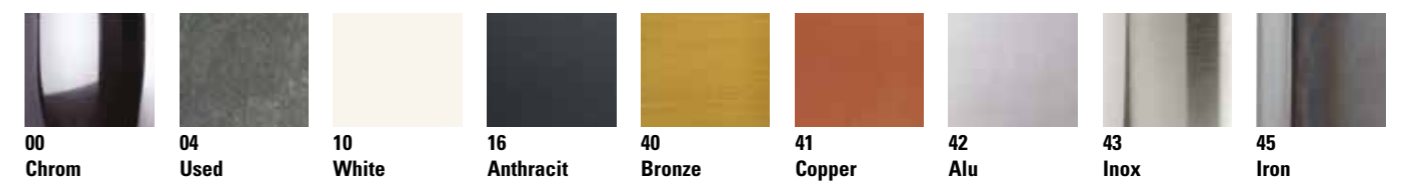

**Chrom = Metall verchromt** | métal chromé | metal chrome  
**Used = Metall galvanisiert** | métal galvanisé | metal galvanised  
**White = Metall pulverbeschichtet** | métal thermolaqué | metal powder-coated  
**Anthracit = Metall pulverbeschichtet** | métal thermolaqué | metal powder-coated  
**Bronze = Metall lackiert** | métal laqué | metal lacquered

**Copper = Metall lackiert** | métal laqué | metal lacquered  
**Alu = Metall pulverbeschichtet** | métal thermolaqué | metal powder-coated  
**Inox = Edelstahl gebürstet** | acier inoxydable brossé | stainless steel brushed  
**Iron = Metall geflammt, pulverbeschichtet** | métal flammé, thermolaqué | metal mottled, powder-coated

# Kopfteile | têtes de lit | headboards



**Dimension** 140, 160, 180, 200



**Dimension:** 140, 160, 180, 200



**Dimension:** 140, 160, 180, 200



**Dimension:** 140, 160, 180, 200

**Gewünschte Liegefläche (Länge)** = zu bestellende **Bettrahmenlänge**  
surface de couchage souhaitée (longueur) = longueur de cadre de lit à commander  
desired mattress lying area (length) = length of bedframe to be ordered

**190** = **200**  
**200** = **210**  
**210** = **220**

## gepolstert | rembourrées | upholstered

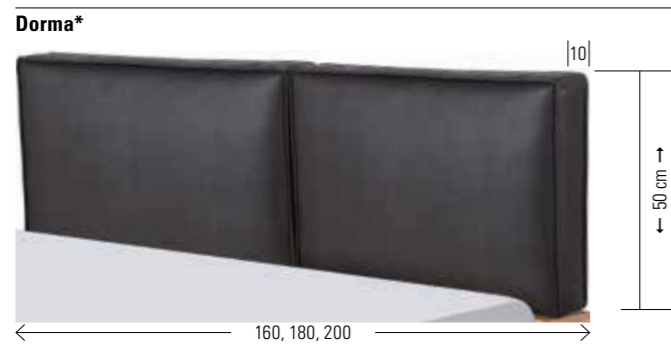

**Dimension:** 160, 180, 200



**Dimension:** 160, 180, 200

\*nur mit Bettrahmen Piato möglich | uniquement possible avec cadre de lit Piato | only possible with bed frame Piato

## Adapter | adaptateur | adapter

Bei hohen Matratzen kann mit dem Verlängerungsadapter das Kopfteil um 9 oder 13 cm erhöht werden.

La tête de lit peut être rehaussée de 9 ou 13 cm avec l'adaptateur quand le matelas est plus épais. With the extension adapter the headboard can be extended 9 or 13 cm if mattresses are high.

**Head-Plus**  
Metall | métal | metal

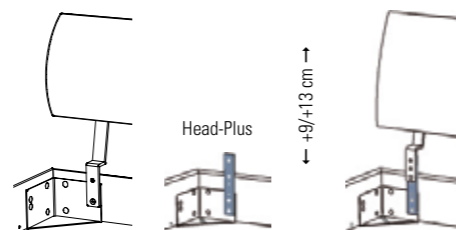

# Kissen zu Kopfteilen | coussins pour têtes de lit | cushions for headboards

**Arona + Duetto**



**Ravo + Varus**



**Varo + Varus**



**Lumo + Duetto**



**Suny + Varus**



### Befestigung mit 2 Bändern (Klettverschluss)

Fixation avec 2 bandes (Velcro®)  
Fixation with 2 ribbons (Velcro® fastener)

### Stoffauswahl/Farben für Kissen siehe Register 1, Seiten 8–9

Choix de tissus/couleurs pour coussins voir index 1, pages 8–9  
Choice of tissues/colours for cushions see index 1, pages 8–9

Kissen   coussins   cushions	Effektive Masse cm dimension effective cm effective dimension cm	zu Kopfteilen pour têtes de lit for headboards		Breitenmasse cm dimensions de largeur cm widths dimensions cm
		Duetto	Varus	
Arona	136, 156, 176×3,5×25	●		140, 160, 180/200
Lumo	136, 156, 176×6×25	●		140, 160, 180/200
Ravo	130, 150, 170, 190×3,5×35	●	●	140, 160, 180, 200
Suny*	55×6×40	●	●	
Varo*	55×10×35	●	●	

\*2er Set | set de 2 | set of 2

## Ausführungen | exécutions | executions

### Holz | bois | wood

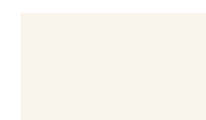

**10**  
**Buche weiss deckend, lackiert**  
Hêtre blanc couvrant, laqué  
Beech white covered, lacquered



**71**  
**Eiche bianco, geölt**  
Chêne bianco, huilé  
Oak bianco, oiled



**80**  
**Kernbuche natur, geölt**  
Hêtre cœur rouge naturel, huilé  
Heart beech natural, oiled



**85**  
**Nussbaum, geölt**  
Noyer, huilé  
Walnut, oiled

**Kopfteile in allen Holz-Ausführungen erhältlich**  
Têtes de lit disponibles dans toutes les versions bois  
Headboards in all wooden executions available

## Nachttische, Kommoden | tables de nuit, commodes | bedside tables, chests of drawers



**Füsse** | pieds | feet = Option zu | pour | for Sica, Trino, Casia



**Sekretär** | secrétaire | bureau

**Griffe** | poignées | handles



**Ausführungen** | exécutions | executions

**Holz** | bois | wood



## Beimöbel | accessoires | accessories

**Bank + Kissen** | banquette + coussin | bench + cushion



**Metallstange/Rückplatte links und rechts montierbar inklusive Holzablage Tray**  
barre métallique/plaque arrière peut être montée à gauche et à droite, vide poche Tray inclus  
metal bar/back plate can be assembled left and right, wood tray included

**Bettkasten** | coffre à literie | bedding box



**Voraussetzungen für Einsatz Box Bettkasten**

**Generell**  
Bettfußhöhe von mindestens 20 cm erforderlich.

**Seitlich**  
Keine Crosstraver, keine Midtraver, nur mit Crosstraver-Twin.

**Frontal**  
Nur bei 140 cm Breite, nicht mit Kufen Indus, Slid und Vilo, keine Crosstraver-Twin, keine Midtraver, nur mit Crosstraver.

**Optionen**  
Deckel Cover nur in weiss, Stoffabdeckung Sacco in Polyester grau.

**Conditions d'utilisation d'un coffre à literie Box**

**En général**  
Une hauteur de pieds de lit d'au moins 20 cm est nécessaire.

**Insertion latérale**  
Pas de Crosstraver, pas de Midtraver, uniquement avec Crosstraver-Twin.

**Insertion frontale**  
Uniquement pour largeur 140 cm, pas avec des patins Indus, Slid et Vilo, pas de Crosstraver-Twin, pas de Midtraver, uniquement avec Crosstraver.

**Options**  
Couvercle Cover uniquement en blanc, tissu de protection Sacco en polyester gris.

**Requirements for using bedding box Box**

**General**  
Feet of bed need a minimum height of 20 cm.

**Laterally**  
No Crosstraver, no Midtraver, only with Crosstraver-Twin.

**Frontal**  
Only with width 140 cm, not with vats Indus, Slid and Vilo, no Crosstraver-Twin, no Midtraver, only with Crosstraver.

**Options**  
Cover only in white, tissue of protection Sacco in polyester grey.

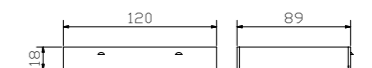

## Nachttische, Kommoden | tables de nuit, commodes | bedside tables, chests of drawers

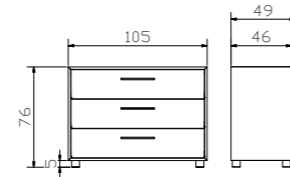
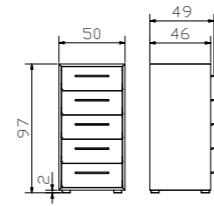
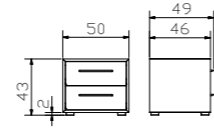

### Griffe | poignées | handles

#### Metall | métal | metal



**Modo, Tola, Chest**  
standardmässig mit Holzgriffen, optional Covo und Rivo Griffe. **Korpus = MDF betonfarbig lackiert, Innenschubladen = Akazie massiv, grau lackiert; Fronten in allen aufgeführten Holz Ausführungen erhältlich** | standard avec poignées en bois, en option poignées Covo et Rivo. Corps = mdf teinté beton, laqué; tiroirs intérieur = acacia massif, gris laqué, façades dans tous les exécutions en bois mentionnés disponible | with wooden handles standard, optional Covo and Rivo handles. Corpus = mdf concrete coloured, lacquered; inside drawers = solid acacia, grey lacquered, fronts in all listed wooden executions available

### Füsse | pieds | feet = Option zu | pour | for Modo, Tola, Chest



## Nachttische, Beimöbel | tables de nuit, accessoires | bedside tables, accessories

**Duqa** anthracit, white

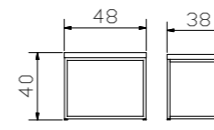

**Lina** anthracit, bronze, copper

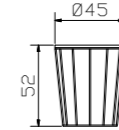

**Nali** anthracit, bronze, copper

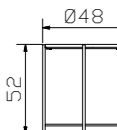

**Rico 46 + 54** FSC

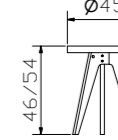

**Tree**

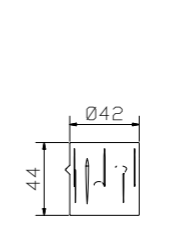

**Dado**

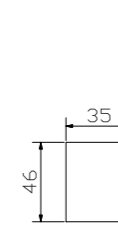

**Duqa, Rico = Auflageplatte Echtbeton** | plaque d'appui béton véritable | support plate real concrete  
**Tree, Dado = Echtbeton, Farb- und Strukturunterschiede sind naturbedingte Eigenschaften** | béton véritable, les différences de couleurs et structures sont des particularités naturelles. | real concrete, differences in colour and structures are natural characteristics.

### Ausführungen | exécutions | executions

#### Holz | bois | wood

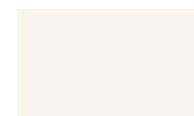

**10**  
**Buche weiss deckend, lackiert**  
Hêtre blanc couvrant, laqué  
Beech white covered, lacquered



**71**  
**Eiche bianco, geölt**  
Chêne bianco, huilé  
Oak bianco, oiled



**80**  
**Kernbuche natur, geölt**  
Hêtre coeur rouge naturel, huilé  
Heart beech natural, oiled



**85**  
**Nussbaum, geölt**  
Noyer, huilé  
Walnut, oiled

#### Beton | béton | concrete



**20**  
**Beton grey**  
béton grey  
concrete grey



**21**  
**Beton white**  
béton white  
concrete white

### Blumotion



**Für unsere Nachttische und Kommoden verwenden wir ausschliesslich den gedämpften Selbsteinzug Blumotion von BLUM.**

Pour nos tables de nuit et commodes nous utilisons exclusivement les tiroirs avec système d'amortissement Blumotion de BLUM.

For our bedside tables and chests of drawers we utilize exclusively the silent and soft self closing drawer runner Blumotion of BLUM.



				Dimension cm
<b>Aska</b>	Sekretär	secrétaire	bureau	120/60/85
<b>Circo 44</b>	Nachttisch/Hocker	table de nuit/tabouret	bedside table/stool	Ø 45/44
<b>Trino</b>	Nachttisch	table de nuit	bedside table	50/44/57
<b>Snake* alu</b>	Lampen (2er Set) 12V DC, 6 LED 3 Beleuchtungsarten Energieeffizienzklasse A-A++	lampes (set de 2) 12V DC, 6 LED 3 différent illuminations classe d'efficacité énergétique A-A++	lamps (set of 2) 12V DC, 6 LED 3 different illuminations energy efficiency class A-A++	



**Details siehe Seite 8.5**  
Détails voir page 8.5  
Details see page 8.5

				Dimension cm
<b>Trento 23</b>	Rahmen Breiten Längen	cadre largeurs longueurs	frame widths lengths	140, 160, 180, 200 200, 210, 220
<b>Practico-Box</b>	Breiten Längen Höhe	largeurs longueurs hauteur	widths lengths height	140, 160, 180, 200 200, 210, 220 25
	Details siehe Seite 8.5	détails voir page 8.5	details see page 8.5	
<b>Varus</b>	Kopfteil	tête de lit	headboard	140, 160, 180, 200
<b>Ravo</b>	Kissen Alpina lightgrey 390	coussin, Alpina lightgrey 390	cushion, Alpina lightgrey 390	140, 160, 180, 200

**Alle Holzteile in Kernbuche natur, geölt** | toutes les parties en bois en hêtre cœur rouge naturel huilé | all wooden parts in heart beech natural, oiled  
\*Lampen siehe Register 2 | lampes voir index 2 | lamps see index 2

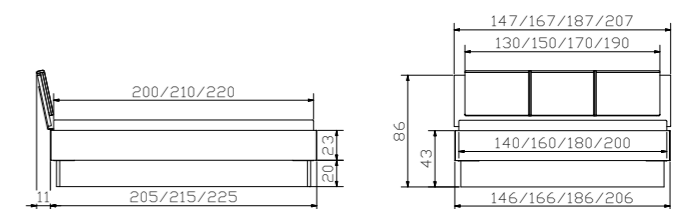



				Dimension cm
<b>Aska</b>	Sekretär	secrétaire	bureau	120/60/85
<b>Tree</b>	Nachttisch/Hocker	table de nuit/tabouret	bedside table/stool	Ø 42/44
<b>Modo</b>	Nachttisch	table de nuit	bedside table	50/49/51
<b>Jone 10 anthracit</b>	Füße	pieds	feet	
<b>Smart* black</b>	Lampen (2er Set), schwarz 12V DC, 30 LED warm Dreistufenschaltung Energieeffizienzklasse A-A++	lampes (set de 2), noir 12V DC, 30 LED warm interrupteur à 3 crans classe d'efficacité énergétique A-A++	lamps (set of 2), nero 12V DC, 30 LED warm three step circuit energy efficiency class A-A++	

				Dimension cm
<b>Piato 18</b>	Rahmen Breiten Längen	cadre largeurs longueurs	frame widths lengths	160, 180, 200 200, 210, 220
<b>Slid anthracit</b>	Kufen Breiten Höhen	patins largeurs hauteurs	vats widths heights	20, 25
<b>Talma</b>	Kopfteil, Boston tizo 654 siehe Register 1	tête de lit, Boston tizo 654 voir index 1	headboard, Boston tizo 654 see index 1	160, 180, 200

**Alle Holzteile in Kernbuche natur, geölt** | toutes les parties en bois en hêtre coeur rouge naturel, huilé | all wooden parts in heart beech natural, oiled  
**Korpus Modo MDF betonfarbig lackiert; Tree Echtbeton** | corps Modo en mdf teinté béton, Tree béton véritable | corpus Modo in mdf concrete coloured, lacquered;  
 Tree real concrete

\*Lampen siehe Register 2 | lampes voir index 2 | lamps see index 2

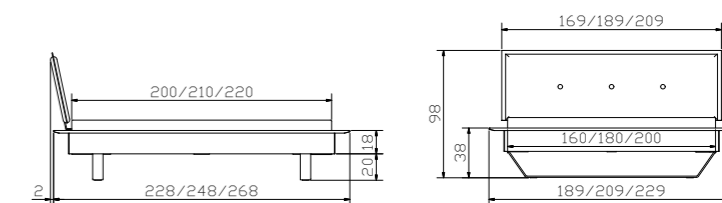



				Dimension cm
<b>Tola</b>	Kommode	commode	chest of drawers	50/49/97
<b>Silvio alu</b>	Herrendiener	valet	dressboy	45/28/103
<b>Modo</b>	Nachttisch	table de nuit	bedside table	50/49/43

				Dimension cm
<b>Piato 18</b>	Rahmen Breiten Längen	cadre largeurs longueurs	frame widths lengths	160, 180, 200 200, 210, 220
<b>Tondo anthracit</b>	Füße Höhe	pieds hauteur	feet height	20
<b>Obag</b>	Kopfteil, Casual carbon 334 siehe Register 1	tête de lit, Casual carbon 334 voir index 1	headboard, Casual carbon 334 see index 1	160, 180, 200

**Alle Holzteile in Nussbaum, geölt** | toutes les parties en bois en noyer, huilé | all wooden parts in walnut, oiled  
**Korpus Tola + Modo MDF betonfarbig lackiert** | corps Tola + Modo en mdf teinté béton | corpus Tola + Modo in mdf concrete coloured, lacquered

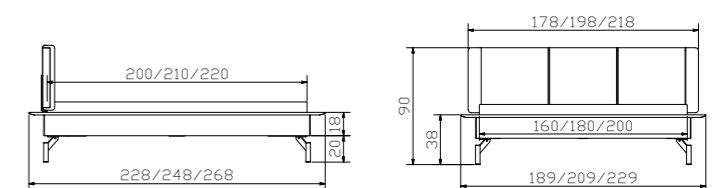



				Dimension cm
<b>Casia</b>	Kommode	commode	chest of drawers	105/49/71
<b>Sola</b>	Bank	banquette	bench	140/37/38
<b>Topia</b>	Kissen, Kabo calc 630	coussin, Kabo calc 630	cushion, Campos blanc 372	140/37/10
<b>Sica</b>	Nachttisch	table de nuit	bedside table	50/44/39

				Dimension cm
<b>Piato 18</b>	Rahmen Breiten Längen	cadre largeurs longueurs	frame widths lengths	160, 180, 200 200, 210, 220
<b>Masi</b>	Füße Höhen	pieds hauteurs	feet heights	10, 20, 25
<b>Cussina</b>	Kopfteil, Kabo calc 630 siehe Register 1	tête de lit, Kabo calc 630 voir index 1	headboard, Kabo calc 630 see index 1	160, 180, 200

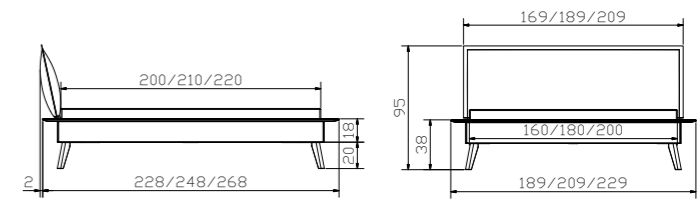

Alle Holzteile in Eiche bianco, geölt | toutes les parties en bois en chêne bianco, huilé | all wooden parts in oak bianco, oiled



				Dimension cm
<b>Atrium</b> alu	Garderobenmöbel	meuble de penderie	wardrobe furniture	110/54/119
<b>Sica</b>	Nachttisch	table de nuit	bedside table	50/44/47
<b>Sima 10</b>	Füße	pieds	feet	
<b>Boa*</b> chrom	Lampen (2er Set) 12V DC, 12 LED warm Energieeffizienzklasse A-A++	lampes (set de 2) 12V DC, 12 LED warm classe d'efficacité énergétique A-A++	lamps (set of 2) 12V DC, 12 LED warm energy efficiency class A-A++	

				Dimension cm
<b>Piato 18</b>	Rahmen Breiten Längen	cadre largeurs longueurs	frame widths lengths	160, 180, 200 200, 210, 220
<b>Masi</b>	Füße Höhen	pieds hauteurs	feet heights	10, 20, 25
<b>Vola</b>	Kopfteil	tête de lit	headboard	160, 180, 200

**Alle Holzteile in Buche weiss deckend, lackiert oder Nussbaum, geölt** | toutes les parties en bois en hêtre blanc couvrant, laqué ou en noyer, huilé | all wooden parts in beech white covered, lacquered or walnut, oiled

**\*Lampen siehe Register 2** | lampes voir index 2 | lamps see index 2

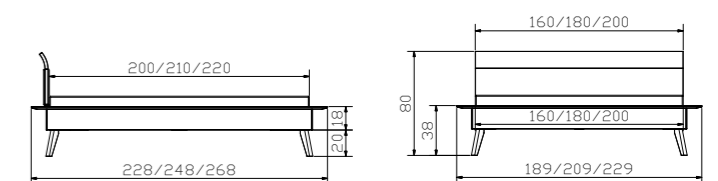



				Dimension cm
<b>Trino</b>	Nachttisch	table de nuit	bedside table	50/44/57
<b>Atrium anthracit</b>	Garderobenmöbel	meuble de penderie	wardrobe furniture	110/54/119
<b>Smart* white</b>	Lampen (2er Set), weiss 12V DC, 30 LED warm Dreistufenschaltung Energieeffizienzklasse A-A++	lamps (set de 2), blanc 12V DC, 30 LED warm interrupteur à 3 crans classe d'efficacité énergétique A-A++	lamps (set of 2), white 12V DC, 30 LED warm three step circuit energy efficiency class A-A++	

				Dimension cm
<b>Piato 18</b>	Rahmen Breiten Längen	cadre largeurs longueurs	frame widths lengths	160, 180, 200 200, 210, 220
<b>Slid white</b>	Kufen Breiten Höhen	patins largeurs hauteurs	vats widths heights	20, 25
<b>Opera</b>	Kopfteil, Ranch grit 661	tête de lit, Ranch grit 661	headboard, Ranch grit 661	160, 180, 200

Alle Holzteile in Buche weiss deckend, lackiert | toutes les parties en bois en hêtre blanc couvrant, laqué | all wooden parts in beech white covered, lacquered

\*Lampen siehe Register 2 | lampes voir index 2 | lamps see index 2

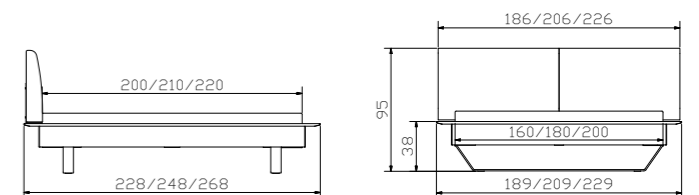

# Trento 23



				Dimension cm
<b>Sola</b>	Bank	banquette	bench	140/37/38
<b>Vano</b>	Kissen, Kabo rust 631	coussin, Kabo rust 631	cushion, Kabo rust 631	136/34/3
<b>Casia</b>	Kommode	commode	chest of drawers	105/49/76
<b>Jone 10</b>	Füsse	pieds	feet	
<b>Sica</b>	Nachttisch	table de nuit	bedside table	50/44/47
<b>Jone 10</b>	Füsse	pieds	feet	

				Dimension cm
<b>Trento 23</b>	Rahmen	cadre	frame	
	Breiten	largeurs	widths	140, 160, 180, 200
	Längen	longueurs	lengths	200, 210, 220
<b>Jeno white</b>	Füsse	pieds	feet	
	Höhen	hauteurs	heights	10, 20, 25
<b>Duetto</b>	Kopfteil	tête de lit	headboard	140, 160, 180, 200
<b>Arona</b>	Kissen, Shine stone 685	coussin, Shine stone 685	cushion, Shine stone 685	140, 160, 180/200

Alle Holzteile in Buche weiss deckend, lackiert | toutes les parties en bois en hêtre blanc, couvrant, laqué | all wooden parts in beech white covered, lacquered

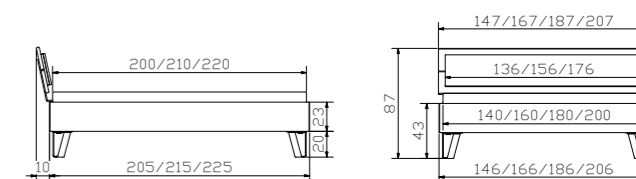



				Dimension cm
<b>Alto</b>	Kommode	commode	chest of drawers	50/49/111
<b>Trino</b>	Nachttisch	table de nuit	bedside table	50/44/57
<b>Silvio alu</b>	Herrendiener	valet	dressboy	45/28/103

				Dimension cm
<b>Trento 23</b>	Rahmen Breiten Längen	cadre largeurs longueurs	frame widths lengths	140, 160, 180, 200 200, 210, 220
<b>Ivio</b>	Füsse Höhen	pieds hauteurs	feet heights	20, 25, 30
<b>Malta</b>	Kopfteil, Alpina smoke 394 siehe Register 1	tête de lit, Alpina smoke 394 voir index 1	headboard, Alpina smoke 394 see index 1	140, 160, 180, 200

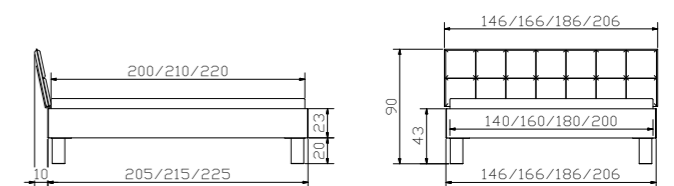

Alle Holzteile in Buche weiss deckend, lackiert | toutes les parties en bois en hêtre blanc, couvrant, laqué | all wooden parts in beech white covered, lacquered



				Dimension cm
<b>Atrium</b> alu	Garderobenmöbel	meuble de penderie	wardrobe furniture	110/54/119
<b>Trino</b>	Nachttisch	table de nuit	bedside table	50/44/57

				Dimension cm
<b>Trento 23</b>	Rahmen Breiten Längen	cadre largeurs longueurs	frame widths lengths	140, 160, 180, 200 200, 210, 220
<b>Slid</b> white	Kufen Breiten Höhen	patins largeurs hauteurs	vats widths heights	140, 160, 180, 200 20, 25
<b>Carina</b>	Kopfteil Echtleder Real bianco 505	tête de lit cuir véritable Real bianco 505	headboard real leather Real bianco 505	140, 160, 180, 200

Alle Holzteile in Eiche bianco, geölt | toutes les parties en bois en chêne bianco, huilé | all wooden parts in oak bianco, oiled

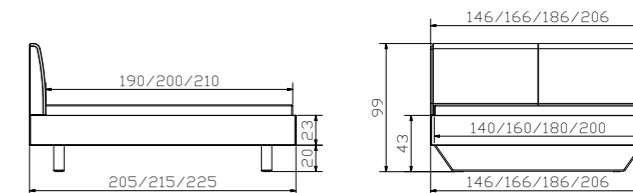





				Dimension cm
<b>Aska</b>	Sekretär	secrétaire	bureau	120/60/85
<b>Circo 44</b>	Nachttisch/Hocker	table de nuit/tabouret	bedside table/stool	∅ 45/44
<b>Sica</b>	Nachttisch	table de nuit	bedside table	50/44/47
<b>Sima 10</b>	Füsse	pieds	feet	

				Dimension cm
<b>Trento 23</b>	Rahmen Breiten Längen	cadre largeurs longueurs	frame widths lengths	140, 160, 180, 200 200, 210, 220
<b>Masi</b>	Füsse Höhen	pieds hauteurs	feet heights	10, 20, 25
<b>Vola</b>	Kopfteil	tête de lit	headboard	140, 160, 180, 200

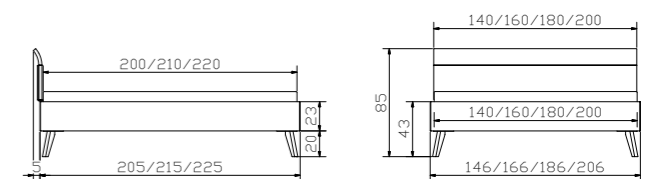
Alle Holzteile in Eiche bianco, geölt | toutes les parties en bois en chêne bianco, huilé | all wooden parts in oak bianco, oiled





				Dimension cm
<b>Alto</b>	Kommode	commode	chest of drawers	50/49/111
<b>Silvio</b> inox	Herrendiener	valet	dressboy	45/28/103
<b>Quad</b> white	Nachttisch	table de nuit	bedside table	48/38/39
<b>Smart*</b> white	Lampen (2er Set) weiss 12V DC, 30 LED warm Dreistufenschaltung Energieeffizienzklasse A-A++	lamps (set de 2) blanc 12V DC, 30 LED warm interrupteur à 3 crans classe d'efficacité énergétique A-A++	lamps (set of 2) white 12V DC, 30 LED warm three step circuit energy efficiency class A-A++	

				Dimension cm
<b>Trento 23</b>	Rahmen Breiten Längen	cadre largeurs longueurs	frame widths lengths	140, 160, 180, 200 200, 210, 220
<b>Cantu</b>	Füße Höhen	pieds hauteurs	feet heights	20, 25, 30
<b>Varus</b> <b>Varo</b>	Kopfteil Kissen (2er Set) Kabo lagoon 633	tête de lit coussins (set de 2) Kabo lagoon 633	headboard cushions (set of 2) Kabo lagoon 633	140, 160, 180, 200 55/10/35

Alle Holzteile in Eiche bianco, geölt | toutes les parties en bois en chêne bianco, huilé | all wooden parts in oak bianco, oiled

\*Lampen siehe Register 2 | lampes voir index 2 | lamps see index 2

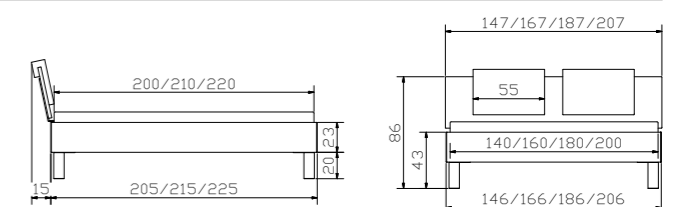



				Dimension cm
<b>Chest</b>	Kommode	commode	chest of drawers	105/49/76
<b>Modo</b>	Nachttisch	table de nuit	bedside table	50/49/43
<b>Tola</b>	Kommode	commode	chest of drawers	50/49/97

				Dimension cm
<b>Trento 23</b>	Rahmen Breiten Längen	cadre largeurs longueurs	frame widths lengths	140, 160, 180, 200 200, 210, 220
<b>Slid</b>	Kufen Breiten Höhe	patins largeurs hauteur	vats widths height	140, 160, 180, 200 20
<b>Carina</b>	Kopfteil, Ranch grit 661	tête de lit, Ranch grit 661	headboard, Ranch grit 661	140, 160, 180, 200

**Alle Holzteile in Nussbaum, geölt** | toutes les parties en bois en noyer, huilé | all wooden parts in walnut, oiled  
**Korpus Chest, Modo +Tola MDF betonfarbig lackiert** | corps Chest, Modo + Tola en mdf teinté béton | corpus Chest, Modo + Tola in mdf concrete coloured, lacquered

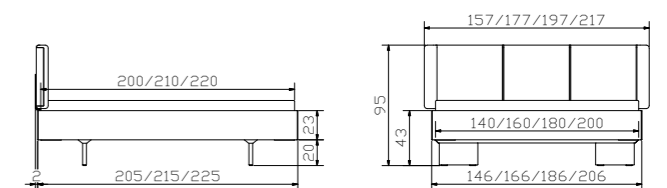



				Dimension cm
<b>Casia</b>	Kommode	commode	chest of drawers	105/49/76
<b>Sima 10</b>	Füße	pieds	feet	
<b>Sica</b>	Nachttisch	table de nuit	bedside table	50/44/47
<b>Sima 10</b>	Füße	pieds	feet	

				Dimension cm
<b>Trento 23</b>	Rahmen Breiten Längen	cadre largeurs longueurs	frame widths lengths	140, 160, 180, 200 200, 210, 220
<b>Masi</b>	Füße Höhen	pieds hauteurs	feet heights	10, 20, 25
<b>Ripo</b>	Kopfteil, Kitana grigio 602 siehe Register 1	tête de lit, Kitana grigio 602 voir index 1	headboard, Kitana grigio 602 see index 1	140, 160, 180, 200

Alle Holzteile in Nussbaum, geölt | toutes les parties en bois en noyer, huilé | all wooden parts in walnut, oiled

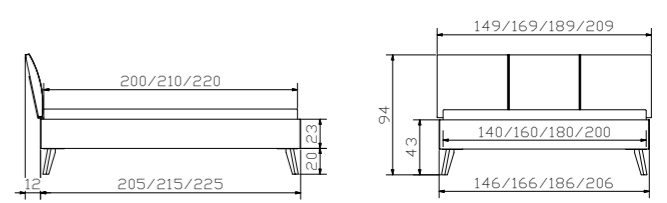



				Dimension cm
<b>Alto</b>	Kommode	commode	chest of drawers	50/49/111
<b>Silvio inox</b>	Herrendiener	valet	dressboy	45/28/103
<b>Caja</b>	Nachttisch	table de nuit	bedside table	48/41/16

				Dimension cm
<b>Trento 23</b>	Rahmen Breiten Längen	cadre largeurs longueurs	frame widths lengths	140, 160, 180, 200 190 (200), 200 (210), 210 (220)
<b>Indus inox</b>	Kufen Breiten Höhen	patins largeurs hauteurs	vats widths heights	140, 160, 180, 200 20, 25
<b>Cena</b>	Kopfteil, Linen offwhite 340	tête de lit, Linen offwhite 340	headboard, Linen offwhite 340	140, 160, 180, 200
	hat Einfluss auf Bettlänge siehe Register 1 Seite 4	a un impact sur la longueur du lit voir index 1 page 4	affects the length of bed see index 1 page 4	

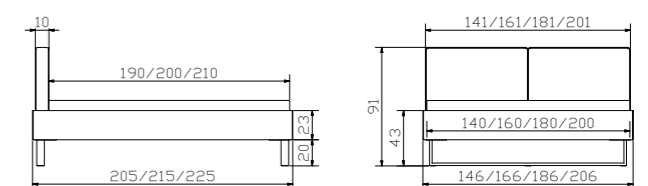

Alle Holzteile in Kernbuche natur, geölt | toutes les parties en bois en hêtre cœur rouge naturel, huilé | all wooden parts in heart beech natural, oiled



				Dimension cm
<b>Casia</b>	Kommode	commode	chest of drawers	105/49/76
<b>Jone 10 anthracit</b>	Füße	pieds	feet	
<b>Quad anthracit</b>	Nachttisch	table de nuit	bedside table	48/38/39

				Dimension cm
<b>Trento 23</b>	Rahmen Breiten Längen	cadre largeurs longueurs	frame widths lengths	140, 160, 180, 200 200, 210, 220
<b>Jeno anthracit</b>	Füße Höhen	pieds hauteurs	feet heights	10, 20, 25
<b>Vola</b>	Kopfteil	tête de lit	headboard	140, 160, 180, 200

Alle Holzteile in Kernbuche natur, geölt | toutes les parties en bois en hêtre cœur rouge naturel huilé | all wooden parts in heart beech natural, oiled

