



swiss bed concept

  
**HASENA**  
the dream factory



# OAKWILD

**Wildeiche massiv** | chêne noueux massif | solid wildoak

#### Wild und ungezähmt

Durch die natürlich vorkommenden Äste und Markstrahlen der Wild-Eiche entstehen faszinierende Farb- und Struktur-Differenzen, die unseren massiven Möbelstücken aus der Oak-Wild-Reihe ihren aussergewöhnlich lebendigen Charakter verleihen. Die vielzähligen Füsse und Kopfteile eröffnen zudem spannende Kombinationsmöglichkeiten mit unterschiedlichen Materialien.

Eichenholz ist ein Naturmaterial, das im Laufe der Jahre reift und seinen Charakter ändert. Bei der Ausführung Wild wird bewusst mit Rissen und Ästen versehenes Holz verwendet, um den speziellen Wild-Look und Charakter zu erreichen.

Farb- und Strukturunterschiede sind bei Echtholz naturbedingte Eigenschaften.

#### Sauvage et indompté

Les branches naturelles et les rayons médullaires du chêne sauvage créent des différences de couleur et de structure fascinantes qui confèrent à nos meubles massifs de la gamme Oak-Wild leur caractère extraordinairement vivant. Les nombreux pieds et têtes de lit offrent également des possibilités de combinaison passionnantes avec différents matériaux.

Le bois de chêne est un matériau naturel qui mûrit au fil des ans et change de caractère. La version Wild utilise délibérément du bois avec des fissures et des nœuds pour obtenir l'aspect et le caractère spéciaux Wild.

Les différences de couleur et de structure sont des caractéristiques naturelles du bois véritable.

#### Wild and untamed

The naturally occurring branches and medullary rays of wild oak create fascinating differences in colour and structure, which give our massive pieces of furniture from the Oak-Wild range their extraordinarily lively character. The numerous feet and headboards also open up exciting combination possibilities with different materials.

Oak wood is a natural material that matures over the years and changes its character. The Wild version deliberately uses wood with cracks and knots to achieve the special Wild look and character.

Colour and structure differences are natural characteristics of real wood.



# Bettrahmen | cadre de lit | bedframe

## Cadro 18



**Breiten** | largeurs | widths:  
90, 100, 120, 140, 160, 180, 200 cm

**Längen** | longueurs | lengths:  
190, 200, 210, 220 cm

**Einlegetiefe** | hauteur encastrable | insertion depth:  
18 cm

## Cadro 23



**Breiten** | largeurs | widths:  
120, 140, 160, 180, 200 cm

**Längen** | longueurs | lengths:  
190, 200, 210, 220 cm

**Einlegetiefe** | hauteur encastrable | insertion depth:  
18\*, 23 cm

## Ausführungen | exécutions | executions

### Holz | bois | wood



**93 Wildeiche natur, gebürstet, geölt**  
Chêne nouveaux naturel, brossé, huilé  
Wildoak natural, brushed, oiled



**94 Wildeiche weiss, gebürstet, geölt**  
Chêne nouveaux blanc, brossé, huilé  
Wildoak white, brushed, oiled



**98 Wildeiche coffee, gebürstet, geölt**  
Chêne nouveaux coffee, brossé, huilé  
Wildoak coffee, brushed, oiled

### Balkenbetten in Ausführung weiss/coffee siehe Register Bormio/Cortina.

Lits poutre en exécution blanc/coffee voir index Bormio/Cortina.  
Beam beds in execution white/coffee see index Bormio/Cortina.

## Aosta 16



**Breiten** | largeurs | widths:  
140, 160, 180, 200 cm

**Längen** | longueurs | lengths:  
200, 210, 220 cm

**Einlegetiefe** | hauteur encastrable | insertion depth:  
16 cm

## Pilatus 23



**Breiten** | largeurs | widths:  
140, 160, 180, 200 cm

**Längen** | longueurs | lengths:  
200, 210, 220 cm

**Einlegetiefe** | hauteur encastrable | insertion depth:  
18\*, 23 cm

**Aosta 16 und Pilatus 23 nur in Ausführung Wildeiche natur erhältlich.**  
Aosta 16 et Pilatus 23 ne sont disponibles qu'en chêne nouveaux naturel.  
Aosta 16 and Pilatus 23 are only available in Wildoak natural.

### \* Cadro 23/Pilatus 23

Bei der Einlegetiefe 18 cm sind die Füße/Sockel um 5 cm versenkt und um diese Höhe weniger sichtbar.

Avec la hauteur de cadre 18 cm les pieds/socle sont encastrés de 5 cm sous le cadre et donc moins visibles.  
With the insertion depth 18 cm the feet/socket are sunken in by 5 cm and this height less visible.

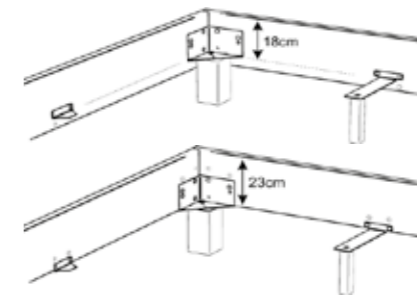

### Option Midtraver-move

nicht bei Füßen in der Höhe 30 cm anwendbar  
ne s'applique pas aux pieds à une hauteur de 30 cm  
not applicable for feet at a height of 30 cm

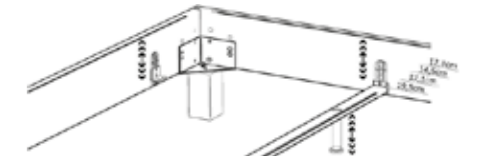

## Traversen | traverses | bars

Wir empfehlen beim Einsatz von preisgünstigen Lattenrosten oder hoher Gewichtsbelastung eine **Crosstraver** (Quertraverse) oder **Crosstraver-Twin** (Quertraversen) beim Einsatz von Box/Conti. Für Betten ab 160 cm mit 2 Lattenrosten oder für den Motorrahmeneinbau eine **Midtraver** (Längstraverse).  
Midtraver und Crosstraver-Twin sind mit den Füßen Vilo nicht einsetzbar.

En cas d'intégration d'un sommier premier prix ou de charge importante nous recommandons une **Crosstraver** (traverse transversale) ou **Crosstraver-Twin** (traverses transversales) avec Box/Conti. Pour un cadre de lit à partir de 160 cm avec 2 sommiers ou pour l'encastrement d'un sommier à moteur une **Midtraver** (traverse centrale).  
Midtraver et Crosstraver-Twin non compatibles avec les pieds Vilo.

We recommend a **Crosstraver** (central cross bar) for use with budget-priced slats or high weight loads or **Crosstraver-Twin** (cross bars) with Box/Conti. For beds wider than 160 cm with 2 slats or motor-frames, a **Midtraver** (central bar).  
Midtraver and Crosstraver-Twin are not suitable with feet Vilo.

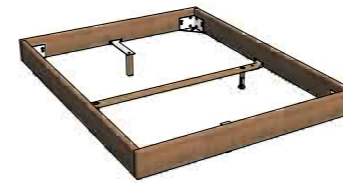

**Crosstraver**  
Quertraverse  
Traverse transversale  
Central cross bar

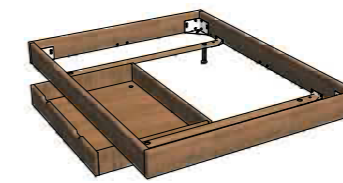

**Crosstraver-Twin**  
Quertraversen  
Traverses transversales  
Cross bars

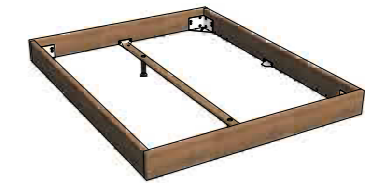

**Midtraver**  
Längstraverse  
Traverse centrale  
Central bar

## Bettkasten | coffre à literie | bedding box

### Practico-Box + Pilatus 23 + Ultrafree-Lift KF



#### Ultrafree-Lift KF



Box = inkl. Boden, Anwendung siehe Seiten 10.14–10.15

**zu Practico-Box:**  
Lattenrost **Ultrafree-Lift KF**  
Kopf-Fussverstellung  
Rahmenholme Höhe 7 cm und 28 Federleisten aus Buchenschichtholz  
Gesamthöhe 11 cm

Lattenrost **Econom-move**  
Unverstellbar  
Rahmenholme Höhe 6 cm und 28 Federleisten aus Buchenschichtholz  
Gesamthöhe 9 cm  
inkl. Gasdruckfedern und allen Beschlägen

### Practico-Box + Cadro 23 + Econom-move



#### Econom-move



box = fond inclus, utilisation voir pages 10.14–10.15

**pour box Practico:**  
Sommier **Ultrafree-Lift KF**  
Tête et pied réglables  
Cadre, hauteur 7 cm et 28 lattes en hêtre multiplis  
Hauteur totale 11 cm

Sommier **Econom-move**  
Non réglable  
Cadre, hauteur 6 cm et 28 lattes en hêtre multiplis  
Hauteur totale 9 cm

Pistons à gaz et toute la quincaillerie inclus

### Stauraum | compartiment de rangement | storage space

90 × 200/210/220	=	81 × 190/200/210 × 24 cm
100 × 200/210/220	=	91 × 190/200/210 × 24 cm
120 × 200/210/220	=	111 × 190/200/210 × 24 cm
140 × 200/210/220	=	131 × 190/200/210 × 24 cm
160 × 200/210/220	=	74 × 190/200/210 × 24 (2 x) cm
180 × 200/210/220	=	84 × 190/200/210 × 24 (2 x) cm
200 × 200/210/220	=	94 × 190/200/210 × 24 (2 x) cm

### Details zu Ultrafree-Lift KF und Econom-move siehe Register 14, Seite 6

Détails pour Ultrafree-Lift KF et Econom-move voir index 14, page 6  
Details for Ultrafree-Lift KF and Econom-move see index 14, pages 6

box = bottom incl., handling see pages 10.14–10.15  
**for Practico box:**  
Slats **Ultrafree-Lift KF**  
Head/footpiece adjustable  
Frame, height 7 cm and 28 slats are of beech veneer board  
Total height 11 cm

Slats **Econom-move**  
Not adjustable  
Frame, height 6 cm and 28 slats are of beech veneer board  
Total height 9 cm

Pneumatic compression spring and all fittings included

# Füsse | pieds | feet

## Holz | bois | wood



	Masse cm dim. cm	Breiten cm largeurs cm widths cm	Höhen cm hauteurs cm heights cm				Holzfarben couleurs bois colours wood					Metallfarben couleurs métal colours metal
			10	20	25	30	10	16	93	94	98	
<b>Holz   bois   wood</b>			10	20	25	30	10	16	93	94	98	45
Cova*	25,5x25,5			•					•	•	•	
Ivio	10x10		•	•	•	•			•	•	•	
Leno	6x5,5			•	•				•	•	•	
Onito iron*	18,5x18,5		•						•	•	•	•
Practico-Box (inkl. Boden   fond inclus   bottom included)		90–200			•		•	•				
Stabil**		140–200			•				•			
Vilo		90–200	•	•			•	•	•	•	•	

\*nur mit Bettrahmen Cadro 18 und Aosta 16 möglich | uniquement possible avec cadres de lit Cadro 18 et Aosta 16 | only possible with bedframes Cadro 18 and Aosta 16

\*\*nur mit Bettrahmen Aosta 16 und Pilatus 23 kombinierbar | uniquement possible avec cadres de lit Aosta 16 et Pilatus 23 | only possible with bedframes Aosta 16 and Pilatus 23

Bei Cadro 23 und Pilatus 23 (Einlegetiefe 18 cm) sind die Füsse/Sockel um 5 cm versenkt und um diese Höhe weniger sichtbar.

Avec Cadro 23 et Pilatus 23 (hauteur de cadre 18 cm) les pieds/sockle sont encastrés de 5 cm sous le cadre et donc moins visibles.

With Cadro 23 and Pilatus 23 (insertion depth 18 cm) the feet/socket are sunken in by 5 cm and this height less visible.

## Ausführungen | exécutions | executions

### Holz | bois | wood



**10 Weiss**  
Blanc  
White

**16 Anthracit**

**93 Wildeiche natur, gebürstet, geölt**  
Chêne nouveaux naturel, brossé, huilé  
Wildoak natural, brushed, oiled

**94 Wildeiche weiss, gebürstet, geölt**  
Chêne nouveaux blanc, brossé, huilé  
Wildoak white, brushed, oiled

**98 Wildeiche coffee, gebürstet, geölt**  
Chêne nouveaux coffee, brossé, huilé  
Wildoak coffee, brushed, oiled

# Füsse | pieds | feet

## Metall | métal | metal



	Masse cm dim. cm	Breiten cm largeurs cm widths cm	Höhen cm hauteurs cm heights cm				Metallfarben couleurs métal colours metal								
			10	20	25	30	00	04	10	16	40	41	42	43	45
<b>Metall   métal   metal</b>			10	20	25	30	00	04	10	16	40	41	42	43	45
Caro	6x6		•	•	•		•			•			•		
Fasio	∅5/9		•	•					•	•	•				
Gina*	3,5x3,5		•	•			•						•	•	
Grado	∅6/10			•			•						•		
Indus	6x2	140–200		•	•				•				•	•	•
Jeno	12x5		•	•	•			•	•						
Jump	∅10/12			•			chromfarbig   teinté chrome   chrome coloured								
Mico	8x8		•	•	•	•	•		•				•	•	•
Quada	20x6,5			•	•		•		•				•	•	•
Reca	24x12		•				•						•	•	
Road**	∅13			•				•							
Slid	8/1	140 - 200		•	•			•	•				•		
Soko	∅6			•	•		•						•		
Stomp	∅8		•	•	•	•	•						•		
Tondo*	∅3,5			•					•	•	•	•			

\*nur mit Bettrahmen Cadro 18 und Aosta 16 möglich | uniquement possible avec cadres de lit Cadro 18 et Aosta 16 | only possible with bedframes Cadro 18 and Aosta 16

\*\*Füsse fixiert, Rollen nur optisch | pieds fixes, roulettes uniquement décoration | feet fixed, castors only visual



**00 Chrom**

**04 Used**

**10 White**

**16 Anthracit**

**40 Bronze**

**41 Copper**

**42 Alu**

**43 Inox**

**45 Iron**

**Chrom = Metall verchromt** | métal chromé | metal chrome

**Used = Metall galvanisiert** | métal galvanisé | metal galvanised

**White = Metall pulverbeschichtet** | métal thermolaqué | metal powder-coated

**Anthracit = Metall pulverbeschichtet** | métal thermolaqué | metal powder-coated

**Bronze = Metall lackiert** | métal laqué | metal lacquered

**Copper = Metall lackiert** | métal laqué | metal lacquered

**Alu = Metall pulverbeschichtet** | métal thermolaqué | metal powder-coated

**Inox = Edelstahl gebürstet** | acier inoxydable brossé | stainless steel brushed

**Iron = Metall geflammt, pulverbeschichtet** | métal flammé, thermolaqué | metal mottled, powder-coated

# Kopfteile | têtes de lit | headboards

**Alpa**



Dimension: 90/100, 120, 140, 160, 180, 200

**Balco\***

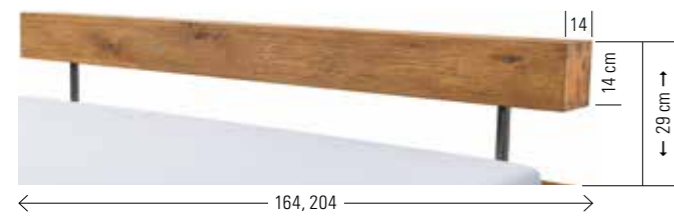

Dimension: 140/160, 180/200

**Naturo**



Dimension: 140, 160, 180, 200

**Sion**



Dimension: 140, 160, 180, 200

**Areba**



Dimension: 140/160, 180/200

**Inca\***



Dimension: 140/160, 180/200

**Capa + Sion**



Capa 2er Set/set de 2/set of 2 für/pour/for Sion

**Holzfarben**  
couleurs bois  
colours wood

Kopfteil   têtes de lit   headboards	93	94	98
Alpa	●	●	●
Areba	●		
Balco	●		
Inca	●		
Sion	●	●	●
Naturo	●		

**\*nur mit Bettrahmen Aosta möglich**  
uniquement possible avec cadre de lit Aosta  
only possible with bed frame Aosta

**Kopfteil-Verlängerungsadapter siehe Seite 11.10**  
Réhausseur pour tête de lit voir page 11.10  
Extension adapter for headboards see page 11.10

# Kissen zu Kopfteilen | coussins pour têtes de lit | cushions for headboards

**Arona + Alpa**



**Lumo + Alpa**



**Nakio + Balco/Inca**



**Ravo + Sion**



**Sano + Sion**



**Sema + Sion**



**Suny + Alpa**



**Stoffauswahl/Farben für Kissen siehe Register 1, Seiten 8–9**  
Choix de tissus/couleurs pour coussins voir index 1, pages 8–9  
Choice of tissues/colours for cushions see index 1, pages 8–9

**Befestigung mit 2 Bändern (Klettverschluss)**  
Fixation avec 2 bandes (Velcro®)  
Fixation with 2 ribbons (Velcro® fastener)

Kissen   coussins   cushions	Effektive Masse cm dimensions effectives cm effective dimensions cm	zu Kopfteilen pour têtes de lit for headboards					Breitenmasse cm dimensions de largeur cm widths dimensions cm
		Alpa	Areba	Balco/Inca	Naturo	Sion	
Arona	86, 116, 136, 156, 176×3,5×25	●			●		90/100, 120, 140, 160, 180/200
Lumo	86, 116, 136, 156, 176×6×25	●			●		90/100, 120, 140, 160, 180/200
Nakio (2er Set   set de 2   set of 2)	55×19×14			●			
Ravo	80, 110, 130, 150, 170, 190×3,5×35	●	●			●	90/100, 120, 140, 160, 180, 200
Sano (2er Set   set de 2   set of 2)	55×4×35	●	●			●	
Sema (2er Set   set de 2   set of 2)	55×4×35	●	●			●	
Suny (2er Set   set de 2   set of 2)	55×6×40	●				●	

## Ausführungen | exécutions | executions

### Holz | bois | wood



**93 Wildeiche natur, gebürstet, geölt**  
Chêne nouveaux naturel, brossé, huilé  
Wildoak natural, brushed, oiled



**94 Wildeiche weiss, gebürstet, geölt**  
Chêne nouveaux blanc, brossé, huilé  
Wildoak white, brushed, oiled



**98 Wildeiche coffee, gebürstet, geölt**  
Chêne nouveaux coffee, brossé, huilé  
Wildoak coffee, brushed, oiled



**45 Iron Metall geflammt, pulverbeschichtet** | métal flammé, thermolaqué | metal mottled, powder-coated

# Kopfteile | têtes de lit | headboards

gepolstert | rembourrées | upholstered

Dorma\*



Dimension: 140, 160, 180, 200

\*nur mit Bettrahmen Aosta möglich | uniquement possible avec cadre de lit Aosta

Opera\*



Dimension: 140, 160, 180, 200

only possible with bed frame Aosta

## Adapter | adaptateur | adapter

Bei hohen Matratzen kann mit dem Verlängerungsadapter das Kopfteil erhöht werden.

La tête de lit peut être rehaussée avec l'adaptateur quand le matelas est plus épais.  
With the extension adapter the headboard can be extended if mattresses are high.

Head-Plus

Metall | métal | metal

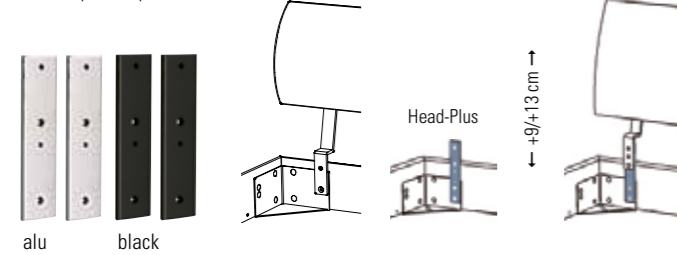

Balco-Hold L (Balco, Inca)

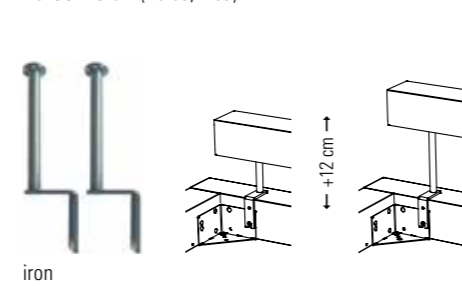

Gepolsterte Kopfteile, Wandpaneele, Stoffauswahl/Farben siehe Register 1, Lampen siehe Register 2.

Têtes de lits rembourrées, panneaux muraux, choix de tissus/couleurs voir index 1, lampes voir index 2.  
Upholstered headboards, wallpanels, choice of tissues/colours see index 1, lamps see index 2.

## Blumotion



Für unsere Nachttische und Kommoden verwenden wir ausschliesslich den gedämpften Selbsteinzug Blumotion von BLUM.

Pour nos tables de nuit et commodes nous utilisons exclusivement les tiroirs avec système d'amortissement Blumotion de BLUM.  
For our bedside tables and chests of drawers we utilize exclusively the silent and soft self closing drawer runner Blumotion of BLUM.

# Nachttische, Kommoden | tables de nuit, commodes | bedside tables, chests of drawers

Osta

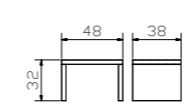

Cubo

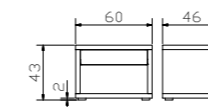

Menza

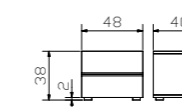

Cera

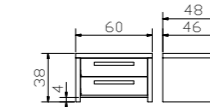

Cera + Covo



Cera + Seca



Caja



Carpi

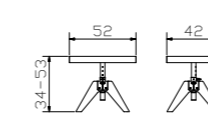

John

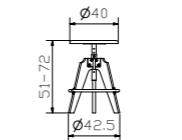

Ludo

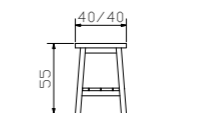

Pira

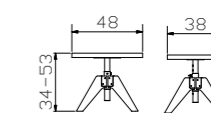

für Montage am Bett  
pour montage au lit  
for assembling directly  
to the bed

höhenverstellbar  
réglable en hauteur  
adjustable in height

inkl. Glasplatte  
plateau en verre inclus  
incl. glass plate

höhenverstellbar  
réglable en hauteur  
adjustable in height

höhenverstellbar  
réglable en hauteur  
adjustable in height

Cerina

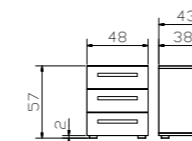

Cerina + Seca



Cessa

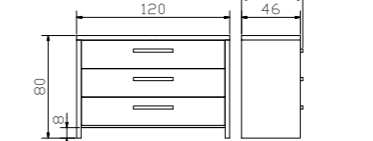

Cessa + Placo



Griffe, Deko siehe Seite 10.12  
Poignées, déco voir page 10.12  
Handles, deco see page 10.12

Modo

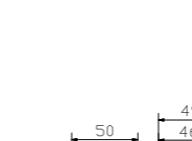

Tola

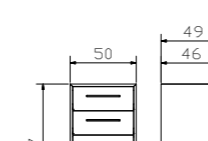

Chest

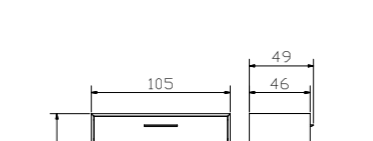

Korpus = MDF betonfarbig lackiert, Innenschubladen = Akazie massiv, grau lackiert; Fronten in Wildeiche natur erhältlich  
Corpus = mdf teinté béton, laqué; tiroirs intérieur = acacia massif, gris lacqué, façades dans chêne nouveau naturel disponible  
Corpus = mdf concrete coloured, lacquered; inside drawers = solid acacia, grey lacquered, fronts in oak natural available

Ausführungen Holz/Metall siehe Seite 10.13  
exécutions bois/métal voir page 10.13  
executions wood/metal see page 10.13

# Zubehör, Beimöbel | accessoires | accessories

## Griffe | poignées | handles



**Cera, Cerina, Cessa, Modo, Tola und Chest standardmässig mit Holzgriffen, optional Covo, Seca und Rivo Griffe.**

Cera, Cerina, Cessa, Modo, Tola et Chest standard avec poignées en bois, en option poignées Covo, Seca et Rivo.

Cera, Cerina, Cessa, Modo, Tola and Chest with wooden handles standard, optional Covo, Seca and Rivo handles.

## Deko | déco | deco



**Placo**  
= Cessa

**3er Set** | set de 3 | set of 3

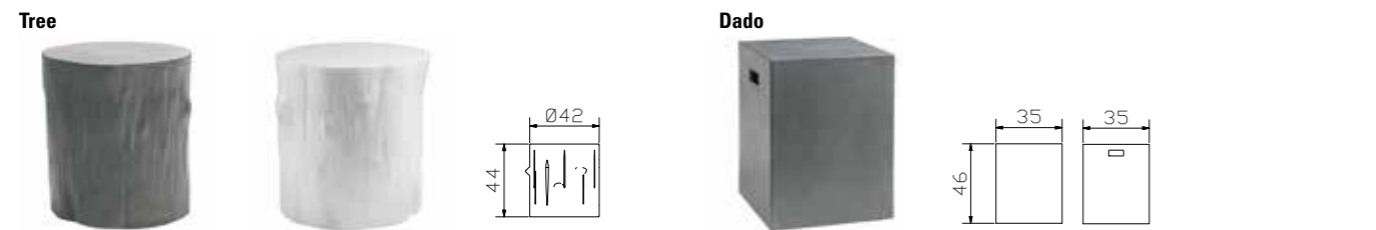

**Tree, Dado = Echtbeton, Farb- und Strukturunterschiede sind naturbedingte Eigenschaften** | béton véritable, les différences de couleurs et structures sont des particularités naturelles. | real concrete, differences in colour and structures are natural characteristics.

## Bank + Kissen | banquette + coussin | bench + cushion

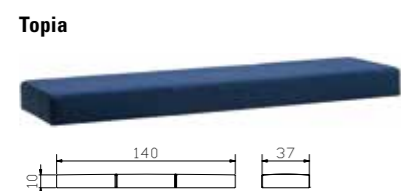
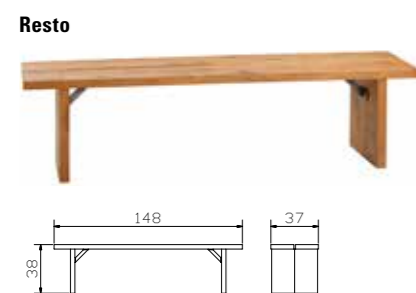

**\*Metallstange/Rückplatte links und rechts montierbar**  
**Option: Tray Holzablage für Atrio = Beton (MDF) lackiert**  
barre métallique/plaque arrière peut être montée à gauche et à droite  
option: vide poche Tray pour Atrio = béton (mdf) laqué  
metal bar/back plate can be assembled left and right  
option: vide poche Tray pour Atrio = béton (mdf) laqué

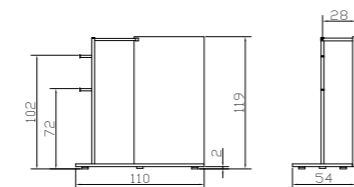

**Vano, Topia**  
**Bezugsstoffe siehe Register 1, Seiten 8 – 9**  
Tissus de revêtement voir index 1, pages 8 – 9  
Cover fabrics see index 1, pages 8 – 9

# Beimöbel | accessoires | accessories

## Herrendiener | valet | dressboy

**Claudio** alu, anthracit, iron, chrom, inox

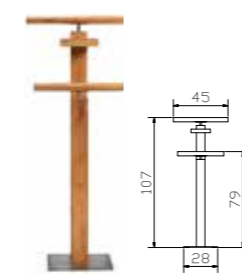

## Sekretär | secrétaire | bureau

**Coset**



**Vecio**

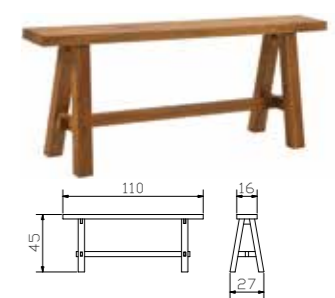

## Bettkasten | coffre à literie | bedding box

**Conti**



**Voraussetzungen für Einsatz Conti Bettkasten**

**Generell**  
Bettflurhöhe von mindestens 20 cm erforderlich.

**Seitlich**  
Keine Crosstraver, keine Midtraver, nur mit Crosstraver-Twin.

**Frontal**  
Nur bei 140 cm Breite, nicht mit Kufen Indus, Slid, Stabil und Vilo, keine Crosstraver-Twin, keine Midtraver, nur mit Crosstraver.

**Optionen**  
Deckel Cover nur in weiss, Stoffabdeckung Sacco in Polyester grau.

**Conti + Cover**



**Conditions d'utilisation d'un coffre à literie Conti**

**En général**  
Une hauteur de pieds de lit d'au moins 20 cm est nécessaire.

**Insertion latérale**  
Pas de Crosstraver, pas de Midtraver, uniquement avec Crosstraver-Twin.

**Insertion frontale**  
Uniquement pour largeur 140 cm, pas avec des patins Indus, Slid, Stabil et Vilo, pas de Crosstraver-Twin, pas de Midtraver, uniquement avec Crosstraver.

**Options**  
Couvercle Cover uniquement en blanc, tissu de protection Sacco en polyester gris.

**Conti + Sacco**



**Requirements for using bedding box Conti**

**General**  
Feet of bed need a minimum height of 20 cm.

**Laterally**  
No Crosstraver, no Midtraver, only with Crosstraver-Twin.

**Frontal**  
Only with width 140 cm, not with vats Indus, Slid, Stabil et Vilo, no Crosstraver-Twin, no Midtraver, only with Crosstraver.

**Options**  
Cover only in white, tissue of protection Sacco in polyester grey.

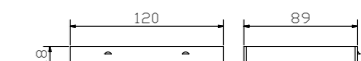

## Ausführungen | exécutions | executions

### Holz | bois | wood

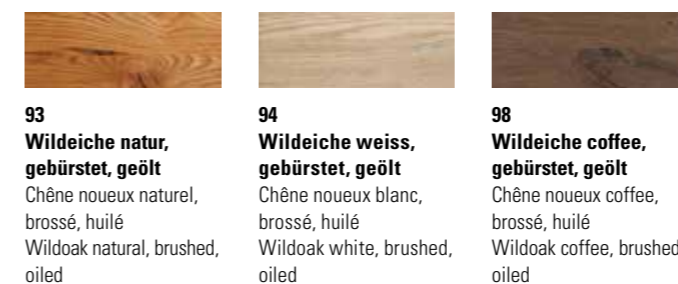

### Metall | métal | metal

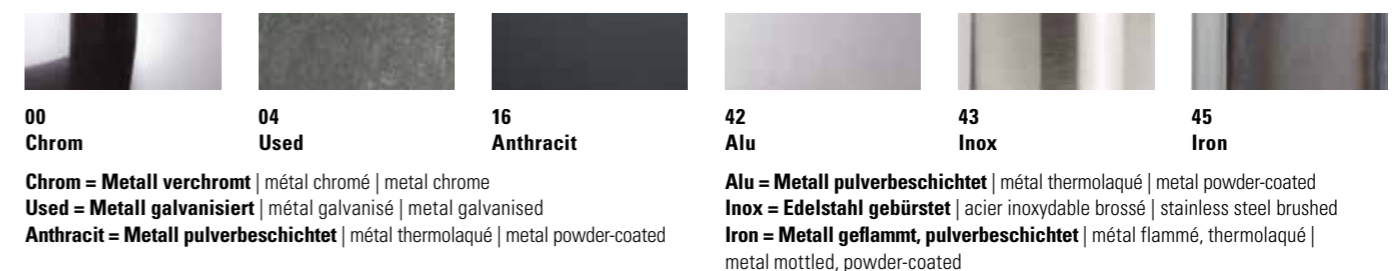

**Chrom = Metall verchromt** | métal chromé | metal chrome  
**Used = Metall galvanisiert** | métal galvanisé | metal galvanized  
**Anthracit = Metall pulverbeschichtet** | métal thermolaqué | metal powder-coated

**Alu = Metall pulverbeschichtet** | métal thermolaqué | metal powder-coated  
**Inox = Edelstahl gebürstet** | acier inoxydable brossé | stainless steel brushed  
**Iron = Metall geflammt, pulverbeschichtet** | métal flammé, thermolaqué | metal mottled, powder-coated

### Beton | béton | concrete

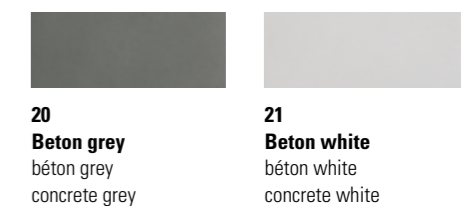



				Dimension cm
<b>Coset</b>	Sekretär	secrétaire	bureau	120/60/86
<b>Vecio</b>	Bank	banquette	bench	110/27/45
<b>Caja</b>	Nachttisch	table de nuit	bedside table	48/41/16
<b>Smart* white</b>	Lampen (2er Set), weiss 12V DC, 30 LED warm Dreistufenschaltung Energieeffizienzklasse A-A++	lampes (set de 2), blanc 12V DC, 30 LED warm interrupteur à 3 crans classe d'efficacité énergétique A-A++	lamps (set of 2), white 12V DC, 30 LED warm three step circuit energy efficiency class A-A++	

				Dimension cm
<b>Cadro 23</b>	Rahmen Breiten Längen	cadre largeurs longueurs	frame widths lengths	120, 140, 160, 180, 200 200, 210, 220
<b>Practico-Box</b>	Weiss Breiten Längen Höhe	blanc largeurs longueur hauteur	white widths lengths height	120, 140, 160, 180, 200 200, 210, 220 25
<b>Malta</b>	Kopfteil, Kabo calc 630 siehe Register 1	tête de lit, Kabo calc 630 voir index 1	headboard, Kabo calc 630 see index 1	120, 140, 160, 180, 200

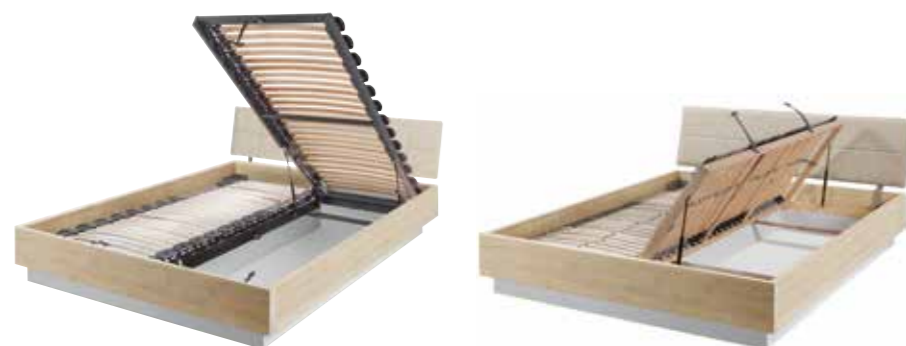

**Details siehe Seite 10.5**  
Détails voir page 10.5  
Details see page 10.5

**Alle Holzteile in Wildeiche weiss, gebürstet, geölt** | toutes les parties en bois en chêne nouveau blanc, brossé, huilé | all wooden parts in wildoak white, brushed, oiled  
\*Lampen siehe Register 2 | lampes voir index 2 | lamps see index 2

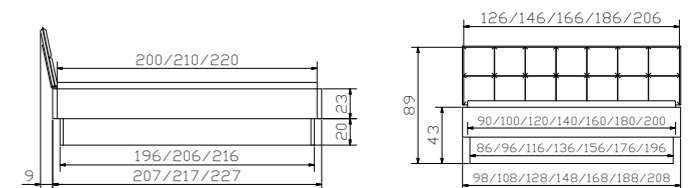



				Dimension cm
<b>Resto</b>	Bank	banquette	bench	148/37/38
<b>Vano</b>	Kissen, Casual carbon 334	coussin, Casual carbon 334	cushion, Casual carbon 334	136/34/3
<b>Ludo</b>	Nachttisch/Hocker	table de nuit/tabouret	bedside table/stool	40/40/55
<b>Smart* black</b>	Lampen (2er Set), schwarz 12V DC, 30 LED warm Dreistufenschaltung Energieeffizienzklasse A-A++	lampes (set de 2), noir 12V DC, 30 LED warm interrupteur à 3 crans classe d'efficacité énergétique A-A++	lamps (set of 2), black 12V DC, 30 LED warm three step circuit energy efficiency class A-A++	

				Dimension cm
<b>Pilatus 23</b>	Rahmen Breiten Längen	cadre largeurs longueurs	frame widths lengths	140, 160, 180, 200 200, 210, 220
<b>Quada anthracit</b>	Füße Höhen	pieds hauteurs	feet heights	20, 25
<b>Ripo</b>	Kopfteil, Casual carbon 334 siehe Register 1	tête de lit, Casual carbon 334 voir index 1	headboard, Casual carbon 334 see index 1	140, 160, 180, 200

Alle Holzteile in Wildeiche natur, gebürstet, geölt | toutes les parties en bois en chêne nouveau naturel, brossé, huilé | all wooden parts in wildoak natural, brushed, oiled  
\*Lampen siehe Register 2 | lampes voir index 2 | lamps see index 2

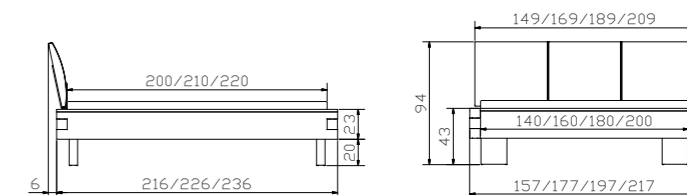





				<b>Dimension cm</b>
<b>Alpa</b>	Kopfteil	tête de lit	headboard	140, 160, 180, 200
<b>Pilatus 23</b>	Rahmen Breiten Längen	cadre largeurs longueurs	frame widths lengths	140, 160, 180, 200 200, 210, 220
<b>Ivio</b>	Füße Höhen	pieds hauteurs	feet heights	10, 20, 25, 30

				<b>Dimension cm</b>
<b>Pilatus 23</b>	Rahmen Breiten Längen	cadre largeurs longueurs	frame widths lengths	140, 160, 180, 200 200, 210, 220
<b>Ivio</b>	Füße Höhen	pieds hauteurs	feet heights	10, 20, 25, 30
<b>Sion</b>	Kopfteil	tête de lit	headboard	140, 160, 180, 200
<b>Caja</b>	Nachttisch	table de nuit	bedside table	48/41/16

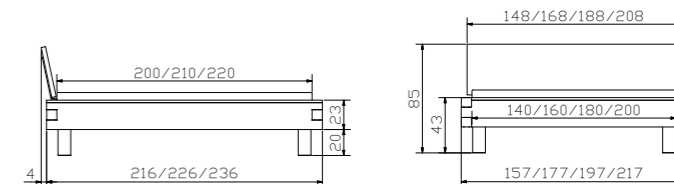
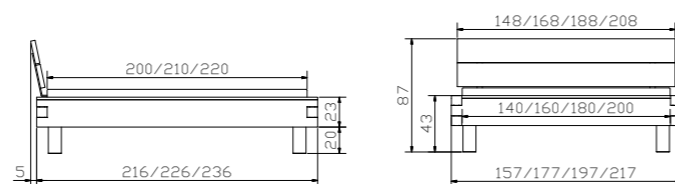
**Alle Holzteile in Wildeiche natur, gebürstet, geölt** | toutes les parties en bois en chêne naturel, brossé, huilé | all wooden parts in wildoak natural, brushed, oiled





				<b>Dimension cm</b>
<b>Vecio</b>	Bank	banquette	bench	110/27/45
<b>John iron</b>	Nachttisch/Hocker höhenverstellbar	table de nuit/tabouret réglable en hauteur	bedside table/stool adjustable in height	∅ 42,5/51 – 72
<b>Boa* chrom</b>	Lampen (2er Set) 12V DC, 12 LED warm Energieeffizienzklasse A-A++	lampes (set de 2) 12V DC, 12 LED warm classe d'efficacité énergétique A-A++	lamps (set of 2) 12V DC, 12 LED warm energy efficiency class A-A++	

				<b>Dimension cm</b>
<b>Pilatus 23</b>	Rahmen Breiten Längen	cadre largeurs longueurs	frame widths lengths	140, 160, 180, 200 200, 210, 220
<b>Grado chrom</b>	Füße Höhen	pieds hauteurs	feet heights	10, 20
<b>Sion Sano</b>	Kopfteil Kissen (2er Set), Casual olive 333	tête de lit coussins (set de 2), Casual olive 333	headboard cushions (set of 2), Casual olive 333	140, 160, 180, 200 55/4/35

Alle Holzteile in Wildeiche natur, gebürstet, geölt | toutes les parties en bois en chêne nouveau naturel, brossé, huilé | all wooden parts in wildoak natural, brushed, oiled

\*Lampen siehe Register 2 | lampes voir index 2 | lamps see index 2

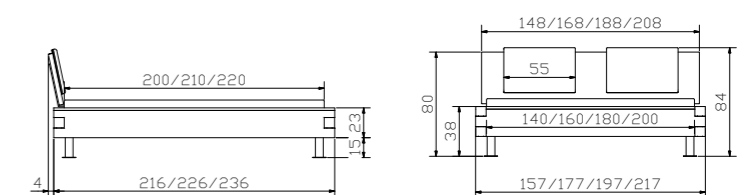



<b>Cerina</b>	Nachttisch	table de nuit	bedside table	<b>Dimension cm</b> 48/43/57
---------------	------------	---------------	---------------	---------------------------------

<b>Cadro 23</b>	Rahmen Breiten Längen	cadre largeurs longueurs	frame widths lengths	<b>Dimension cm</b> 120, 140, 160, 180, 200 190, 200, 210, 220
<b>Ivio</b>	Füße Höhen	pieds hauteurs	feet heights	10, 20, 25, 30
<b>Almeno XL</b>	Wandpaneel, Kitana grigio 602 nur für Wandmontage siehe Register 1	panneau mural, Kitana grigio 602 uniquement pour montage mural voir index 1	wall panel, Kitana grigio 602 wall assembly only see index 1	168, 188, 208

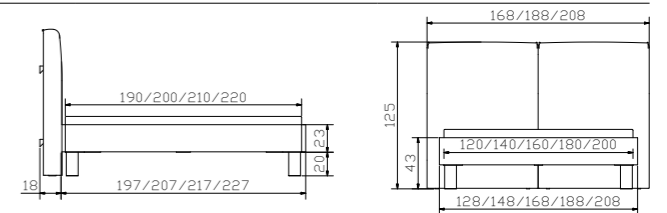

Alle Holzteile in Wildeiche natur, gebürstet, geölt | toutes les parties en bois en chêne nouveau naturel, brossé, huilé | all wooden parts in wildoak natural, brushed, oiled



				Dimension cm
<b>Claudio</b> alu	Herrendiener	valet	dressboy	45/28/107
<b>Ludo</b>	Nachttisch/Hocker	table de nuit/tabouret	bedside table/stool	40/40/55
<b>Tree</b>	Nachttisch/Hocker	table de nuit/tabouret	bedside table/stool	∅ 42/44

				Dimension cm
<b>Cadro 23</b>	Rahmen Breiten Längen	cadre largeurs longueurs	frame widths lengths	120, 140, 160, 180, 200 190, 200, 210, 220
<b>Leno</b>	Füsse Höhe	pieds hauteur	feet height	20
<b>Obag</b>	Kopfteil, Campos blanc 372 siehe Register 1	tête de lit, Campos blanc 372 voir index 1	headboard, Campos blanc 372 see index 1	140, 160, 180, 200

**Alle Holzteile in Wildeiche weiss, gebürstet, geölt** | toutes les parties en bois en chêne noueux blanc, brossé, huilé | all wooden parts in wildoak white, brushed, oiled  
**Tree in Echtbeton white** | Tree en béton véritable white | Tree in real concrete white

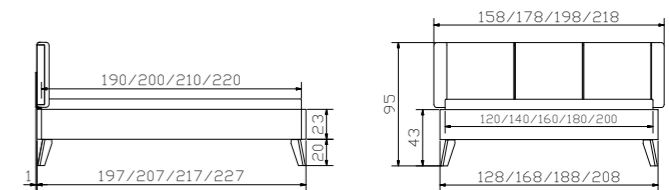



				Dimension cm
<b>Coset</b>	Sekretär	secrétaire	bureau	120/60/86
<b>John iron</b>	Nachttisch/Hocker höhenverstellbar	table de nuit/tabouret réglable en hauteur	bedside table/stool adjustable in height	∅ 42,5/51 – 72
<b>Cessa Seca iron</b>	Kommode Griffe (3er Set)	commode poignées (set de 3)	chest of drawers handles (set of 3)	120/48/80
<b>Carpi</b>	Nachttisch höhenverstellbar	table de nuit réglable en hauteur	bedside table adjustable in height	52/42/34 – 53

				Dimension cm
<b>Cadro 23</b>	Rahmen Breiten Längen	cadre largeurs longueurs	frame widths lengths	120, 140, 160, 180, 200 190, 200, 210, 220
<b>Indus iron</b>	Kufen Breiten Höhen	patins largeurs hauteurs	vats widths heights	140, 160, 180, 200 20, 25
<b>Sion Ravo</b>	Kopfteil Kissen, Alpina anthrazit 391	tête de lit coussin, Alpina anthrazit 391	headboard cushion, Alpina anthrazit 391	140, 160, 180, 200 140, 160, 180, 200

Alle Holzteile in Wildeiche natur, gebürstet, geölt | toutes les parties en bois en chêne nouveau naturel, brossé, huilé | all wooden parts in wildoak natural, brushed, oiled

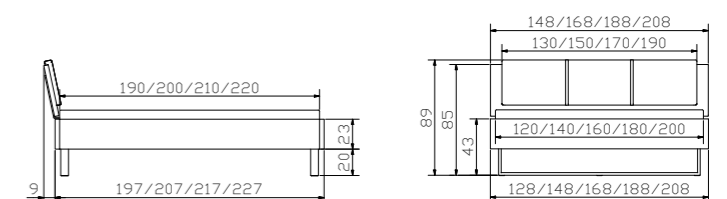



				Dimension cm
<b>Coset</b>	Sekretär	secrétaire	bureau	120/60/86
<b>Tree</b>	Nachttisch/Hocker	table de nuit/tabouret	bedside table/stool	∅ 42/44
<b>Cera</b>	Nachttisch	table de nuit	bedside table	60/48/38
<b>Slid anthracit</b>	Kufen	patins	vats	140, 160, 180, 200
	Breiten	largeurs	widths	20, 25
	Höhen	hauteurs	heights	

				Dimension cm
<b>Aosta 16</b>	Rahmen	cadre	frame	140, 160, 180, 200
	Breiten	largeurs	widths	200, 210, 220
	Längen	longueurs	lengths	
<b>Ivio</b>	Füße	pieds	feet	10, 20, 25, 30
	Höhen	hauteurs	heights	
<b>Naturo</b>	Kopfteil	tête de lit	headboard	140, 160, 180, 200

Alle Holzteile in Wildeiche natur, gebürstet, geölt | toutes les parties en bois en chêne nouveau naturel, brossé, huilé | all wooden parts in wildoak natural, brushed, oiled  
 Tree in Echtbeton white | Tree en beton véritable white | Tree in real concrete white

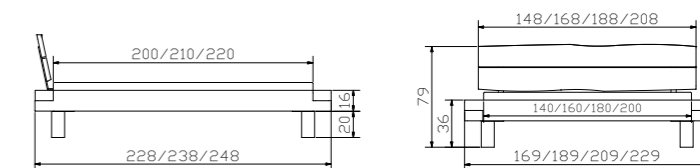



				Dimension cm
<b>Chest</b>	Kommode	commode	chest of drawers	105/49/76
<b>Tree</b>	Nachttisch/Hocker	table de nuit/tabouret	bedside table/stool	Ø 42/44

**Bei hohen Matratzen kann mit dem Verlängerungsadapter das Kopfteil um 12 cm erhöht werden.**

La tête de lit peut être rehaussée de 12 cm avec l'adaptateur quand le matelas est plus épais.  
With the extension adapter the headboard can be extended 12 cm if mattresses are high.

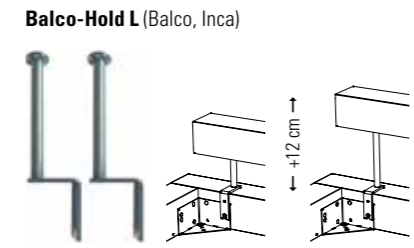

**Alle Holzteile in Wildeiche natur, gebürstet, geölt** | toutes les parties en bois en chêne nouveau naturel, brossé, huilé | all wooden parts in wildoak natural, brushed, oiled  
**Korpus Chest MDF betonfarbig lackiert** | corps Chest en mdf teinté béton, laqué | corpus Chest in mdf concrete coloured, lacquered  
**Tree in Echtbeton grey** | Tree en beton véritable grey | Tree in real concrete grey

				Dimension cm
<b>Aosta 16</b>	Rahmen Breiten Längen	cadre largeurs longueurs	frame widths lengths	140, 160, 180, 200 200, 210, 220
<b>Stabil</b>	Kufen Breiten Höhen	patins largeurs hauteurs	vats widths heights	140, 160, 180, 200 25
<b>Inca Nakio</b>	Kopfteil Kissen (2er Set), Ranch stone 660	tête de lit coussins (set de 2), Ranch stone 660	headboard cushions (set of 2), Ranch stone 660	140/160, 180/200

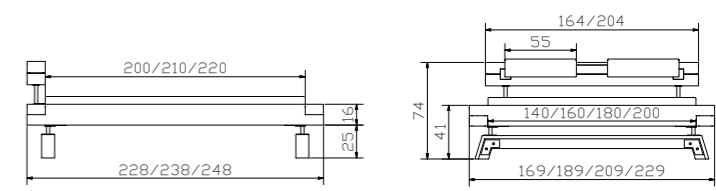



				Dimension cm
<b>Tola</b>	Kommode	commode	chest of drawers	50/49/105
<b>Jone 10 anthracit</b>	Füsse	pieds	feet	
<b>Claudio anthracit</b>	Herrendiener	valet	dressboy	45/28/107
<b>Modo</b>	Nachttisch	table de nuit	bedside table	50/49/51
<b>Jone 10 anthracit</b>	Füsse	pieds	feet	

				Dimension cm
<b>Aosta 16</b>	Rahmen Breiten Längen	cadre largeurs longueurs	frame widths lengths	140, 160, 180, 200 200, 210, 220
<b>Slid anthracit</b>	Kufen Breiten Höhen	patins largeurs hauteurs	vats widths heights	140, 160, 180, 200 20, 25
<b>Opera</b>	Kopfteil, Casual carbon 334	tête de lit, Casual carbon 334	headboard, Casual carbon 334	140, 160, 180, 200

Alle Holzteile in Wildeiche natur, gebürstet, geölt | toutes les parties en bois en chêne nouveau naturel, brossé, huilé | all wooden parts in wildoak natural, brushed, oiled  
 Korpus Tola + Modo MDF betonfarbig lackiert | corps Tola + Modo en mdf teinté béton, laqué | corpus Tola + Modo in mdf concrete coloured, lacquered

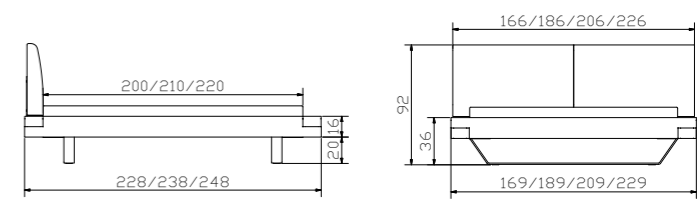



				Dimension cm
<b>Cubo</b>	Nachttisch	table de nuit	bedside table	60/46/43
<b>Cessa</b>	Kommode	commode	chest of drawers	120/48/80

				Dimension cm
<b>Aosta 16</b>	Rahmen Breiten Längen	cadre largeurs longueurs	frame widths lengths	140, 160, 180, 200 200, 210, 220
<b>Indus iron</b>	Kufen Breiten Höhen	patins largeurs hauteurs	vats idths heights	140, 160, 180, 200 20, 25
<b>Sion Capa iron</b>	Kopfteil Deko (2er Set)	tête de lit déco (set de 2)	headboard deco (set of 2)	140, 160, 180, 200

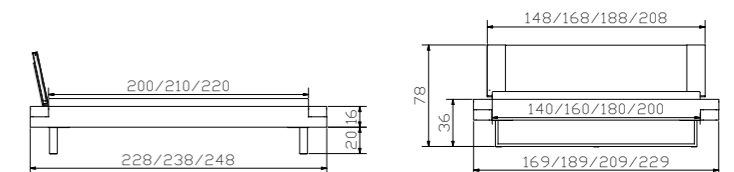

Alle Holzteile in Wildeiche natur, gebürstet, geölt | toutes les parties en bois en chêne nouveau naturel, brossé, huilé | all wooden parts in wildoak natural, brushed, oiled



				Dimension cm
<b>Cessa</b>	Kommode	commode	chest of drawers	120/48/80
<b>Rivo used</b>	Griffe (3er Set)	poignées (set de 3)	handles (set of 3)	
<b>Claudio iron</b>	Herrendiener	valet	dressboy	45/28/107
<b>Carpi</b>	Nachttisch höhenverstellbar	table de nuit réglable en hauteur	bedside table adjustable in height	52/42/34 – 53

				Dimension cm
<b>Cadro 18</b>	Rahmen Breiten Längen	cadre largeurs longueurs	frame widths lengths	90, 100, 120, 140, 160, 180, 200 190 (210), 200 (220)
<b>Jeno used</b>	Füße Höhen	pieds hauteurs	feet heights	10, 20, 25
<b>Rena-step</b>	Kopfteil, Casual olive 333 mit Kontrastnaht beige  hat Einfluss auf Bettlänge siehe Register 1 Seite 5	tête de lit, Casual olive 333 avec surpiqûre beige  a un impact sur la longueur du lit voir index 1 page 5	headboard, Casual olive 333 with contrast stitching beige  affects the length of bed see index 1 page 5	90, 100, 120, 140, 160, 180, 200 90 – 120 = 1 Kissen/coussin/ cushion

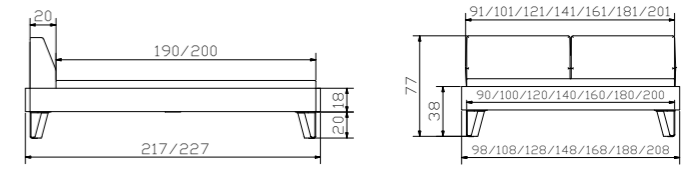

Alle Holzteile in Wildeiche natur, gebürstet, geölt | toutes les parties en bois en chêne nouveau naturel, brossé, huilé | all wooden parts in wildoak natural, brushed, oiled



**Dimension cm**

<b>Alpa Sema</b>	Kopfteil Kissen (2er Set) Casual cognac 332/Cow multicolor	tête de lit coussins (set de 2) Casual cognac 332/Cow multicolor	headboard cushions (set of 2) Casual cognac 332/Cow multicolor	90/100, 120, 140, 160, 180, 200 55/4/35
<b>Snake* alu</b>	Lampen (2er Set) 12V DC, 6 LED 3 Beleuchtungsarten Energieeffizienzklasse A-A++	lamps (set de 2) 12V DC, 6 LED 3 différentes illuminations classe d'efficacité énergétique A-A++	lamps (set of 2) 12V DC, 6 LED 3 different illuminations energy efficiency class A-A++	
<b>Modo Rivo used</b>	Nachttisch Griffe (2er Set)	table de nuit poignées (set de 2)	bedside table handles (set of 2)	50/49/43

**Dimension cm**

<b>Cadro 18</b>	Rahmen Breiten Längen	cadre largeurs longueurs	frame widths lengths	90, 100, 120, 140, 160, 180, 200 190, 200, 210, 220
<b>Onito iron</b>	Füße Höhe	pieds hauteur	feet height	10
<b>Alpa Sema</b>	Kopfteil Kissen (2er Set) Casual carbon 334/Cow multicolor	tête de lit coussins (set de 2) Casual carbon 334/Cow multicolor	headboard cushions (set of 2) Casual carbon 334/Cow multicolor	90/100, 120, 140, 160, 180, 200 55/4/35
<b>Cessa Seca iron</b>	Kommode Griffe (3er Set)	commode poignées (set de 3)	chest of drawers handles (set of 3)	120/48/80
<b>Claudio iron</b>	Herrendiener	valet	dressboy	45/28/107
<b>Osta</b>	Nachttisch	table de nuit	bedside table	48/38/32

**Alle Holzteile in Wildeiche natur, gebürstet, geölt** | toutes les parties en bois en chêne nouveau naturel, brossé, huilé | all wooden parts in wildoak natural, brushed, oiled  
**Korpus Modo MDF betonfarbig lackiert** | corps Modo en mdf teinté béton, laqué | corpus Modo in mdf concrete coloured, lacquered  
**\*Lampen siehe Register 2** | lampes voir index 2 | lamps see index 2

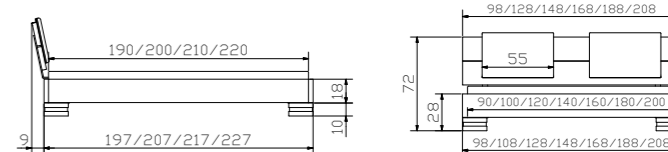



				Dimension cm
<b>Cessa</b>	Kommode	commode	chest of drawers	120/48/80
<b>Claudio inox</b>	Herrendiener	valet	dressboy	45/28/107
<b>Menza</b>	Nachttisch	table de nuit	bedside table	58/40/38

				Dimension cm
<b>Cadro 18</b>	Rahmen Breiten Längen	cadre largeurs longueurs	frame widths lengths	90, 100, 120, 140, 160, 180, 200 190, 200, 210, 220
<b>Slid white</b>	Kufen Breiten Höhen	patins largeurs hauteurs	vats widths heights	140, 160, 180, 200 20, 25
<b>Alpa Ravo</b>	Kopfteil Kissen	tête de lit coussin	headboard cushion	90/100, 120, 140, 160, 180, 200 90/100, 120, 140, 160, 180, 200

Alle Holzteile in Wildeiche weiss, gebürstet, geölt | toutes les parties en bois en chêne noueux blanc, brossé, huilé | all wooden parts in wildoak natural, brushed, oiled

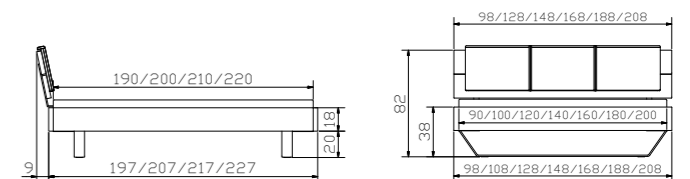



				Dimension cm
<b>Tola</b>	Kommode	commode	chest of drawers	50/49/97
<b>Pira</b>	Nachttisch höhenverstellbar 34–53 cm	table de nuit réglable en hauteur 34–53 cm	bedside table adjustable in height 34 -- 53 cm	48/38/34–53

				Dimension cm
<b>Cadro 18</b>	Rahmen Breiten Längen	cadre largeurs longueurs	frame widths lengths	90, 100, 120, 140, 160, 180, 200 190, 200, 210, 220
<b>Leno</b>	Füße Höhe	pieds hauteur	feet height	20
<b>Boga</b>	Kopfteil, Ranch stone 660 siehe Register 1	tête de lit, Ranch stone 660 voir index 1	headboard, Ranch stone 660 see index 1	90, 100, 120, 140, 160, 180, 200

**Alle Holzteile in Wildeiche natur, gebürstet, geölt** | toutes les parties en bos en chêne nouveau naturel, brossé, huilé | all wooden parts in wildoak natural, brushed, oiled  
**Korpus Tola MDF betonfarbig lackiert; Auflageplatte Pira Echtbeton** | corps Tola en mdf teinté béton, laqué; plaque d'appui Pira béton véritable | corpus Tola in mdf beton coloured, lacquered; support plate Pira real concret

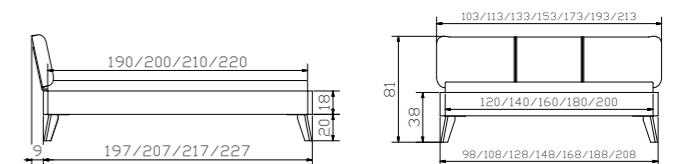



				Dimension cm
<b>Topa*</b>	Bank inkl. Kissen Boston tizo 654	banquette, coussin incl. Boston tizo 654	bench, cushion incl. Boston tizo 654	144/44/38
<b>Caja</b>	Nachttisch	table de nuit	bedside table	48/41/16

				Dimension cm
<b>Cadro 18</b>	Rahmen Breiten Längen	cadre largeurs longueurs	frame widths lengths	90, 100, 120, 140, 160, 180, 200 190 (210), 200 (220)
<b>Slid anthracit</b>	Kufen Breiten Höhen	patins largeurs hauteurs	vats widths heights	140, 160, 180, 200 20, 25
<b>Ceneri</b>	Kopfteil, Boston tizo 654 hat Einfluss auf Bettlänge siehe Register 1 Seite 5	tête de lit, Boston tizo 654 a un impact sur la longueur du lit voir index 1 page 5	headboard, Boston tizo 654 affects the length of bed see index 1 page 5	140, 160, 180, 200

Alle Holzteile in Wildeiche coffee, gebürstet, geölt | toutes les parties en bois en chêne nouveau coffee, brossé, huilé | all wooden parts in wildoak coffee, brushed, oiled

\*Beimöbel siehe Register 2 | accessoires voir index 2 | accessories see index 2

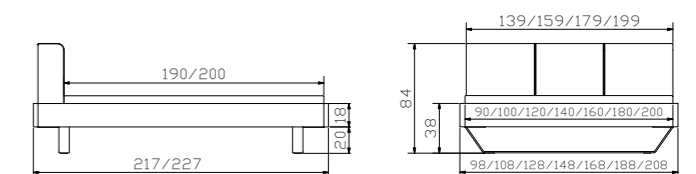



**Dimension cm**

<b>Chest</b>	Kommode	commode	chest of drawers	105/49/76
<b>Rivo used</b>	Griffe (3er Set)	poignées (set de 3)	handles (set of 3)	
<b>Modo</b>	Nachttisch	table de nuit	bedside table	50/49/43
<b>Rivo used</b>	Griffe (2er Set)	poignées (set de 2)	handles (set of 2)	

**Dimension cm**

<b>Cadro 18</b>	Rahmen Breiten Längen	cadre largeurs longueurs	frame widths lengths	90, 100, 120, 140, 160, 180, 200 190, 200, 210, 220
<b>Road used</b>	Füsse fixiert Rollen nur optisch Höhe	pieds fixes roulettes uniquement décoration hauteur	feet fixed castors only visual height	20
<b>Naturo</b>	Kopfteil	tête de lit	headboard	140, 160, 180, 200

**Alle Holzteile in Wildeiche natur, gebürstet, geölt** | toutes les parties en bois en chêne nouveau naturel, brossé, huilé | all wooden parts in wildoak natural, brushed, oiled  
**Korpus Chest + Modo MDF betonfarbig lackiert** | corps Chest + Modo en mdf teinté béton, laqué | corpus Chest + Modo in mdf concrete coloured, lacquered

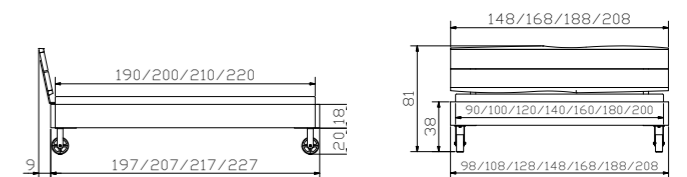



				Dimension cm
<b>Cessa</b>	Kommode	commode	chest of drawers	120/48/80
<b>Claudio iron</b>	Herrendiener	valet	dressboy	45/28/107
<b>Cubo</b>	Nachttisch	table de nuit	bedside table	60/46/43

				Dimension cm
<b>Cadro 18</b>	Rahmen Breiten Längen	cadre largeurs longueurs	frame widths lengths	90, 100, 120, 140, 160, 180, 200 190, 200, 210, 220
<b>Cova</b>	Füße Höhe	pieds hauteur	feet height	20
<b>Cussina</b>	Kopfteil, Shine musk 683 siehe Register 1	tête de lit, Shine musk 683 voir index 1	headboard, Shine musk 683 see index 1	140, 160, 180, 200

Alle Holzteile in Wildeiche natur, gebürstet, geölt | toutes les parties en bois en chêne nouveau naturel, brossé, huilé | all wooden parts in wildoak natural, brushed, oiled

